

SMART
SENSOR
BUSINESS

MD 758i MD 258i

EtherNet/IP and Modbus/TCP



CONNECTING AND OPERATING INSTRUCTIONS

Original Instructions

© 2016

Leuze electronic GmbH + Co. KG

In der Braike 1

D-73277 Owen / Germany

Trademark Notices

Microsoft and Windows are registered trademarks of Microsoft Corporation.

Other product names mentioned herein may be trademarks and/or registered trademarks of their respective owners.

First Edition, August 15, 2016

Copyright © 2016. Leuze electronic.

All Rights Reserved.

Leuze electronic makes no representations or warranties with regard to the contents of this document or to the suitability of the Leuze electronic product for any particular purpose. Specifications subject to change without notice. Some software or features may not be available at the time of publication. Contact your reseller for current product information.

1	Introduction	8
1.1	Product Descripton	8
1.2	Key Features And Benefits.....	8
2	Hardware Installation.....	10
2.1	Setting the Rotary Switch (IP67 Model)	10
2.1.1	MD 758i-11-42/L5-2222 - Setting the Rotary Switch.....	11
2.2	Connecting to the Network	12
2.2.1	MD 758i-11-42/L5-2222 - Connecting to the Network.....	12
2.2.2	MD 258i-12-8K/L4-2R2K - Connecting to the Network	12
2.3	Connecting the Power	12
2.3.1	MD 758i-11-42/L5-2222 - Connecting the Power	13
2.3.2	MD 258i-12-8K/L4-2R2K - Connecting the Power	14
2.4	Mounting the IO-Link Master.....	16
2.4.1	MD 758i-11-42/L5-2222 - Mounting.....	16
2.4.2	MD 258i-12-8K/L4-2R2K - Mounting	16
3	Initial Configuration	17
3.1	Using the Web Interface to Program the Network	17
3.2	Setting User Accounts and Passwords	20
3.3	Configuring Miscellaneous Settings	23
4	Updating Images and Applications	24
4.1	Images and Application Subassemblies Overview	24
4.1.1	Images.....	25
4.1.2	Application Subassemblies	25
4.2	Using the Web Interface to Update Software.....	26
4.2.1	Updating Images	26
4.2.2	Updating Application Subassemblies	27
5	Connecting Devices	28
5.1	Connecting Devices to IO-Link Ports	28
5.1.1	MD 758i-11-42/L5-2222 IO-Link Ports.....	28
5.1.2	MD 258i-12-8K/L4-2R2K IO-Link Ports	29
5.2	Connecting Devices to the Digital IO Ports (MD 258i-12-8K/L4- 2R2K)	31
5.2.1	Connecting to DI	31
5.2.2	Connecting to DIO.....	32
6	IO-Link Port Configuration	33
6.1	Preparing for Port Configuration.....	33
6.2	IO-Link Configuration Page	35
6.2.1	Editing IO-Link Port Settings.....	36
6.2.2	IO-Link Settings Parameters.....	37
6.3	EtherNet/IP Settings Configuration Page.....	40
6.3.1	Editing EtherNet/IP Settings	41
6.3.2	EtherNet/IP Settings Parameters.....	42

6.4	Modbus/TCP Settings Configuration Page	47
6.4.1	Editing Modbus/TCP Settings	48
6.4.2	Modbus/TCP Settings Parameters	49
7	Dedicated Digital I/O Port Configuration	52
7.1	Digital I/O Settings Page	52
7.2	Editing Digital I/O Settings	53
7.3	Digital I/O Setting Parameters	54
8	Loading and Managing IODD Files	56
8.1	IO-Link Device Description Files Page	56
8.1.1	Preparing IODD Files to Upload	56
8.1.2	Uploading IODD Zip Files	57
8.1.3	Uploading xml Files or Supporting Files	59
8.1.4	Viewing and Saving IODD Files	61
8.1.5	Deleting IODD Files	62
8.2	IO-Link Device Configuration Summary Page	63
9	Configuring IO-Link Devices	64
9.1	Port Pages Overview	64
9.2	Editing Parameters - IO-Link Device - Port Table	65
9.3	Resetting IO-Link Device Parameters to Factory Defaults	67
9.4	Editing Parameters - IO-Link Device ISDU Interface - Port	69
10	Utilizing IO-Link Master Features	72
10.1	Data Storage	72
10.1.1	Uploading Data Storage to the IO-Link Master	72
10.1.2	Downloading Data Storage to the IO-Link Device	73
10.1.3	Automatic Device Configuration	74
10.1.4	Automatic Device Configuration Backup	76
10.2	Device Validation	77
10.3	Data Validation	79
10.4	Using the Menu Bar Hover Shows Submenu Option	80
10.5	IO-Link Test Event Generator	80
11	Using the Diagnostics Pages	82
11.1	IO-Link Port Diagnostics	82
11.2	Digital I/O Diagnostics (MD 258i-12-8K/L4-2R2K)	85
11.3	EtherNet/IP Diagnostics	86
11.4	Modbus/TCP Diagnostics	90
12	EtherNet/IP Interface	93
12.1	Introduction	93
12.1.1	Functionality Summary	93
12.1.2	Data Type Definitions	94
12.1.3	Terms and Definitions	95

12.2	Data Transfer Methods.....	96
12.2.1	Receive Process Data Methods	96
12.2.2	Transmit Process Data Methods	98
13	EtherNet/IP CIP Object Definitions	100
13.1	IO-Link Port Information Object Definition (71 hex)	100
13.1.1	Class Attributes	100
13.1.2	Instance Attributes	100
13.1.3	Common Services	101
13.1.4	Instance Attribute Definitions	101
13.2	PDI (Process Data Input) Transfer Object Definition (72 hex)	104
13.2.1	Class Attributes	104
13.2.2	Instance Attributes	105
13.2.3	Common Services	105
13.2.4	Instance Attribute Definitions - Attribute 1 to 4-PDI Data Blocks	105
13.3	PDO (Process Data Output) Transfer Object Definition (73 hex)	106
13.3.1	Class Attributes	106
13.3.2	Instance Attributes	106
13.3.3	Common Services	106
13.3.4	Instance Attribute Definitions - Attribute 1 to 4-PDO Data Blocks	106
13.4	ISDU Read/Write Object Definition (74 hex)	107
13.4.1	Class Attributes	107
13.4.2	Instance Attributes	107
13.4.3	Common Services	107
13.4.4	Object Specific Services	108
13.4.5	Instance Attribute Definitions	108
13.5	Identity Object (01hex, 1 instance).....	108
13.5.1	Class Attributes	108
13.5.2	Instance Attributes	108
13.5.3	Status Word	109
13.5.4	Common Services	110
13.6	Message Router Object (02 hex)	110
13.6.1	Class Attributes	110
13.6.2	Instance Attributes	110
13.6.3	Common Services	110
13.7	Connection Manager Object (06 hex).....	111
13.7.1	Class Attributes Object (06 hex)	111
13.7.2	Instance Attributes (02 hex)	111
13.7.3	Common Services Object (06 hex).....	111
13.8	Port Object (F4 hex-1 instance).....	112
13.8.1	Class Attributes	112
13.8.2	Instance Attributes	112
13.8.3	Common Services	113

13.9 TCP Object (F5 hex-1 instance).....	113
13.9.1 Class Attributes	113
13.9.2 Instance Attributes	114
13.9.3 Common Services.....	115
13.10 Ethernet Link Object (F6 hex-1 instance).....	115
13.10.1 Class Attributes	115
13.10.2 Instance Attributes	116
13.10.3 Services.....	116
13.11 PCCC Object (67 hex-1 instance).....	116
13.11.1 Instances	117
13.11.2 Common Services.....	117
13.11.3 Message Structure Execute_PCCC: Request Message	117
13.11.4 Message Structure Execute_PCCC: Response Message	117
13.11.5 Supported PCCC Command Types.....	118
13.12 Assembly Object (For Class 1 Interface).....	118
13.12.1 Class Attributes	118
13.12.2 Instance Definitions (4-Port Models)	118
13.12.3 Instance Definitions (8-Port Models).....	120
13.12.4 Instance Attributes	122
13.12.5 Common Services.....	122
13.12.6 Instance Attribute Definitions: Attribute 3-Request/Write Data	122
13.12.7 Instance Attribute Definitions: Attribute 4-Data Length	122
13.12.8 Overview of Assembly Interface	123
13.12.9 Grouping of Assembly Instances	124
14 SLC/PLC-5/MicroLogix Interface	128
14.1 Requirements	128
14.2 PLC-5 and SLC 5/05 PLC Requirements.....	128
14.2.1 SLC 5/05.....	128
14.2.2 PLC-5	129
14.3 PLC-5 and SLC Messages.....	129
14.4 Process Data (PDI and PDO) Access via PCCC Messages.....	132
15 EDS Files.....	134
15.1 Overview	134
15.2 Downloading the Files	134
15.3 Adding the IO-Link Master to RSLinx.....	134
15.4 Adding EDS Files to RSLinx.....	134
16 Modbus/TCP Interface	136
16.1 Modbus Function Codes	136
16.2 Modbus Address Definitions	137
16.2.1 8-Port Models	138
16.3 Multiple Port Process Data (PDI/PDO) Access via Modbus/TCP.....	139

17	Functionality Descriptions	141
17.1	Process Data Block Descriptions	141
17.1.1	Input Process Data Block Description	141
17.1.2	Output Process Data Block Description	143
17.2	Event Handling	146
17.2.1	Clear Event After Hold Time Process	147
17.2.2	Clear Event in PDO Block Process	147
17.2.3	Clear Event Code in PDO Block and Clear Event After Hold Time Process- PDO Block First	147
17.2.4	Clear Event Code in PDO Block and Clear Event After Hold Time Process- Hold Time Expires	147
17.3	ISDU Handling	147
17.3.1	ISDU Request/Response Structure	147
17.3.2	ISDU Request Message Format-From PLC to IO-Link Master	150
17.3.3	ISDU Response Message Format	152
17.3.4	ISDU Blocking and Non-Blocking Methods	155
18	Troubleshooting and Technical Support	156
18.1	Troubleshooting	156
18.2	IO-Link Master LEDs	157
18.2.1	MD 758i-11-42/L5-2222	157
18.2.2	MD 258i-12-8K/L4-2R2K	158
18.3	Contacting Technical Support	159
18.4	Using Log Files	160
18.4.1	View a Log File	161
18.4.2	Export a Log File	161
18.4.3	Clear a Log File	162
19	TYPE / SPECIFICATION	163
19.1	MD 758i-11-42/L5-2222	163
19.2	MD 258i-12-8K/L4-2R2K	164

1 Introduction

1.1 Product Description

The Leuze electronic IO-Link Master combines the benefits of the IO-Link standard with the popular industrial EtherNet/IP or Modbus/TCP protocol by providing a gateway that is a streamlined bridge between the field level sensor network and the industrial backbone, making retrofitting or expansion simple.

The MD 758i IO-Link Master features a rugged IP67 slim-line design incorporating two Fast Ethernet ports and four IO-Link ports with Class A M12 connectors.

This product is designed for industrial applications with its machine mount design using industrial grade components.

The MD 258i IO-Link Master easily installs on a standard DIN rail and incorporates two Fast Ethernet ports, eight IO-Link ports, two DI/DO ports and two DI ports.

This product is designed with industrial grade components and redundant power inputs to make it exceptionally reliable for critical applications.

The Leuze electronic IO-Link Masters are easily integrated into factory automation networks and are compatible with both IO-Link and digital IO sensor technologies.

1.2 Key Features And Benefits

- MD 758i
 - Four channel IO-Link Master to EtherNet/IP and Modbus/TCP
 - Rugged IP67 housing designed for harsh environments, M12 connectors allowing up to four sensor connections on one master block
 - Wide operating temperature (0° to +55°C)
- MD 258i
 - Eight port IO-Link Master to EtherNet/IP and Modbus/TCP with additional digital inputs on every port allowing for a possible 10 DI ports with two dedicated DI/DO ports
 - Screw terminal connectors for IO-Link, Power, and Digital IO
 - IP20 DIN rail mount enclosure
 - Wide operating temperature (-40° to +70°C)
- Powerful web GUI for configuration and diagnostics, including:
 - IO-Link device management using the IO-Link device manufacturers IODD file for easy device configuration
 - Automatic data storage (upload and download)
 - Manual data storage (upload and download)
 - Device validation
 - Data validation
- IO-Link V1.0 and V1.1 compatibility
- IO-Link COM1, COM2 and COM3 support (up to 230K baud rate)

This document provides installation, configuration, and embedded web interface information for the Leuze electronic IO-Link Master.

The web interface provides a platform so that you can easily configure, review diagnostic pages, and access advanced features, such as the ability to:

- Upload the latest IO-Link Master images or applications
- Set up user accounts with different user levels and passwords
- Load IODD files and configure IO-Link device parameters
- Implement manual or automatic data storage (upload or download)
- Implement device and/or data validation

The IO-Link Master installation includes the following procedures.

1. Connect the power and Ethernet cable, see Chapter 2.3.
2. **MD 758i-11-42/L5-2222**. If desired, set the rotary switch, see Chapter 2.1.
 - Note: Optionally, you can configure the IP address with software using.*
3. Configure the IP address using the embedded web interface, see Chapter 3.1.
4. Configure IO-Link Master device features such as passwords or miscellaneous settings, see Chapter 3.2, 3.3.
5. If necessary, upload the latest images for the latest features, see Chapter 4.
6. Connect the IO-Link and digital I/O devices, see Chapter 5.
7. Use the web interface to configure the following:
 - a. IO-Link Master ports for your environment using the web interface, see Chapter 6:
 - IO-Link settings, such as the **Port Mode**, which by default is set to IO-Link but depending on the device, you may need to set it to Digital In or Digital Out.
 - EtherNet/IP settings
 - Modbus/TCP settings
 - b. If necessary, configure the dedicated digital I/O ports on applicable models, see Chapter 7.
 - c. If desired, upload the appropriate IODD files for your IO-Link devices, see Chapter 8, for IO-Link device configuration, see Chapter 9.
 - d. If desired, implement IO-Link Master features or options, see Chapter 10, such as:
 - Data storage, automatic or manual - upload or download
 - Device validation
 - Data validation
 - IO-Link Master configuration files (save and load)
 - e. Use the **Diagnostic** pages to monitor or troubleshoot your devices, see Chapter 11.
8. Connect to a PLC and configure the PLC or HMI/SCADA (depending on your protocol)
 - **EtherNet/IP**, which is discussed in detail starting in Chapter 12. EtherNet/IP Interface, through Chapter 15.
 - If appropriate, connect SLC, PLC-5, or MicroLogix PLCs.
 - Add EDS files to RSLinx for normal IO-Link Master-to-PLC communications
 - **Modbus/TCP**. connect PLCs or HMI/ SCADA devices, which is discussed in detail starting in Chapter 16. Modbus/TCP Interface, through Chapter 17.

2 Hardware Installation

Use the following procedures to install the IO-Link Master hardware:

- *Setting the Rotary Switch (IP67 Model), see Chapter 2.1*
- *Connecting to the Network, see Chapter 2.2*
- *Connecting the Power, see Chapter 2.3*
- *Mounting the IO-Link Master, see Chapter 2.4*

Note: *The MD 258i-12-8K/L4-2R2K must be installed in a suitable fire, electrical, mechanical enclosure.*

2.1 Setting the Rotary Switch (IP67 Model)

You can use the rotary switches under the configuration window on the IO-Link Master to set the lower 3-digits (8 bits) of the static IP address. Optionally, you can leave the rotary switch set to the default and use the web interface to set the network address.

If the rotary switches are set to a non-default position, the upper 9-digits (24 bits) of the IP address are then taken from the static network address. The switches only take effect during startup, but the current position is always shown on **Help | SUPPORT** page.

Using the rotary switches to set the IP address may be useful in the following situations:

- A permanent method to assign IP addresses while setting machines for a special application where a PC or laptop is not available.
- A temporary method to assign IP addresses to several IO-Link Masters so that they do not have duplicate addresses to make setting the IP addresses using software easier. After the web page to change the IP address, reset the rotary switches back to 000.
- An emergency method to return the IO-Link Master back to factory defaults, so that software can be used to program the appropriate IP address, and then return the switches back to 000.

Note: *If you set the network address using the rotary switches, the Rotary Switch setting overrides the network settings in the web interface when the IO-Link Master is initially powered on or after cycling the power.*

Switch Setting	Node Address
000 (Default setting)	Use the network configuration stored in the flash. The default network configuration values are: <ul style="list-style-type: none"> • IP address = 192.168.60.101 • Subnet mask = 255.255.255.0 • IP gateway = 0.0.0.0 After completing the hardware installation, see Chapter 3, Initial Configuration, to set the network address using the web interface.
001-254	This is the last three digits in the IP address. This uses the first three numbers from the configured static address, which defaults to 192.168.60.xxx. <i>Note: If software is used to change the IP address to another range before setting the rotary switches, the IO-Link Master uses that IP address range. For example, if the IO-Link Master is set to 10.0.0.250 and the first rotary switch is set to 2, the IP address would be 10.0.0.200.</i>
255-887	Reserved.
888	Reset to factory defaults. If the IO-Link Master is set to 888 and the IP address is changed using other methods, the IP address is returned to the default IP address if the IO-Link Master is rebooted or power cycled.
889-997	Use the network configuration values stored in the flash (reserved).
998	Setting the rotary switches to 998 configures the IO-Link Master to use DHCP addressing.
999	Use the default IP address. If the IO-Link Master is set to 999 and the IP address is changed using other methods, the IP address is returned to the default IP address if the IO-Link Master is rebooted or power cycled.

2.1.1 MD 758i-11-42/L5-2222 - Setting the Rotary Switch

Use the following steps if you want to change the default rotary switch settings.

1. Remove the two Phillips screws securing the switch window.
2. Gently swing open the switch window from the left to the right, allowing it to pivot on the hinge on the right side.
3. Turn each dial to the appropriate position using a small flathead screwdriver.

Note: If you are using the rotary switch to assign a temporary IP address, you may want to leave the door open until you use software to set a permanent IP address. After doing so, you can close and seal the window.

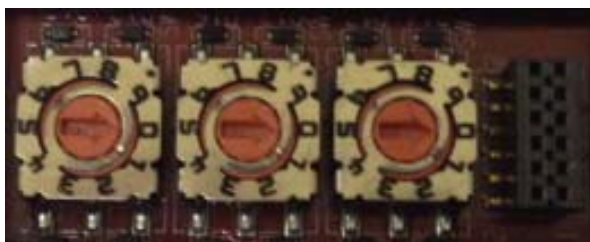

*The default setting is 000 as shown above.
The arrow points to the switch location. 0 is located at the 3:00*

4. Carefully close the window making sure that it is properly aligned.
5. Reinsert and hand-tighten the two screws making sure that the window is securely sealed.

Note: Failure to reassemble the configuration window properly may compromise IP67 integrity.

2.2 Connecting to the Network

Use the appropriate procedure for your IO-Link Master model.

- MD 758i-11-42/L5-2222 - Connecting to the Network, see Chapter 2.1.1
- MD 258i-12-8K/L4-2R2K - Connecting to the Network, see Chapter 2.2.2

2.2.1 MD 758i-11-42/L5-2222 - Connecting to the Network

The IO-Link Master provides two Fast Ethernet (10/100BASE-TX) M12, 4-pin female /D-coded.

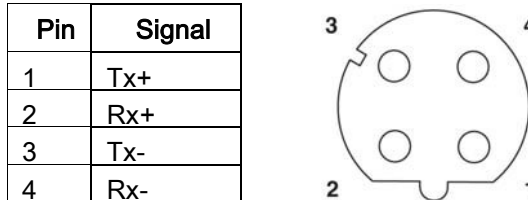

You can use this procedure to connect the IO-Link Master to the network.

1. Securely connect one end of a shielded twisted-pair (Cat 5 or higher) M12 Ethernet cable to either Ethernet port.
2. Connect the other end of the cable to the network.
3. Optionally, use the other Ethernet port to daisy-chain to another Ethernet device.
4. If you did not connect both Ethernet ports, make sure that the unused port is covered with a connector cap to keep dust and liquids from getting in the connector.

Note: Ethernet ports must have an approved cable or protective cover attached to the connector to guarantee IP67 integrity.

2.2.2 MD 258i-12-8K/L4-2R2K - Connecting to the Network

The IO-Link Master provides two Fast Ethernet (10/100BASE-TX) standard RJ45 connectors.

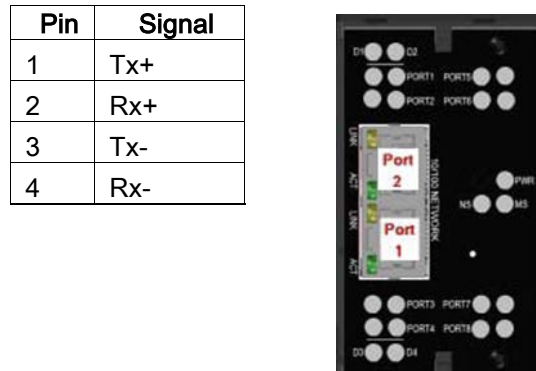

You can use this procedure to connect the IO-Link Master to the network.

1. Securely connect one end of the RJ45 Ethernet cable to either Ethernet port.
2. Connect the other end to the network.
3. Optionally, use the other Ethernet port to daisy-chain to another Ethernet device.

2.3 Connecting the Power

Use the appropriate information for your IO-Link Master model:

- MD 758i-11-42/L5-2222 - Connecting the Power, see Chapter 2.3.1
- MD 258i-12-8K/L4-2R2K - Connecting the Power, see Chapter 2.3.2

2.3.1 MD 758i-11-42/L5-2222 - Connecting the Power

The MD 758i-11-42/L5-2222 provides dual M12 (A-coded) power connectors.

Note: Power connectors must have an approved cable or protective cover attached to the port guarantee to compliance. IP67

Pin	Input - Male	Output - Female
1	L+	L+
2	L2+	L2+
3	L-	L-
4	L2-	L2-
5	Not connected	Not connected

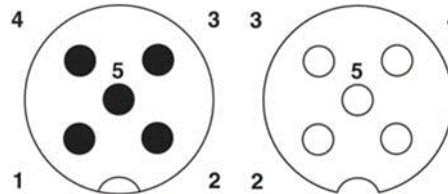

The MD 758i-11-42/L5-2222 requires a UL LPS listed power supply with an output rating of 24VDC.

Power Supply	Values
Power Supply In - Maximum (U_S)	4A
IO-Link Connectors (Ports 1 - 4) C/Q (Pin 4) V_S (Pins 1 and 3)	200 mA (Maximum) 500 mA (Maximum)
IO-Link Master Power	100mA @ 24VDC (V_S)
Power Supply Out (U_S)	4A * (Maximum)
* U_S output available is determined by subtracting the following from the available input current. <ul style="list-style-type: none"> • IO-Link Mode module power • Actual C/Q current for each IO-Link port • Actual V_S current for each IO-Link port 	

You can use this procedure to connect the MD 758i-11-42/L5-2222 to a power supply.

Note: Power should be disconnected from the power supply before connecting it to the MD 758i-11-42/L5-2222. Otherwise, your screwdriver blade can inadvertently short your power supply terminal connections to the grounded enclosure.

1. Securely attach the power cable between the male power connector (PWR In) and the power supply.
2. Either attach a power cable between the female power connector and another device to which you want to provide power or securely attach a connector cap to prevent dust or liquids from getting into the connector.
3. Apply the power and verify that the following LEDs are lit indicating that you are ready to attach your IO-Link or digital I/O devices.
 - **PWR** - green lit LED indicates the MD 758i-11-42/L5-2222 is receiving power.
 - **MOD**, first the flashing green and red LEDs display that it is in self-test mode. After the self-test mode, depending on whether you set the IP address with the rotary switch one of the following occurs:
 - The green LED is flashing to indicate that the IO-Link Master is in standby mode.
 - The green LED is lit to indicate that the IO-Link Master is operational.
 - **NET**, first it flashes green and red indicating that it is in self-test mode. After self-test mode, depending on whether you set the IP address with the rotary switch one of the following occurs:
 - Off indicates there is no IP address.

- Steady red indicates a duplicate IP address on the network.
- LINK should be lit (green) to indicate a valid network connection.
- ACT blinks if there is network traffic between the IO-Link Master and the network.
- EIP 1/2 should be lit (green) indicating that the link is up if both connectors are connected.
- Port LEDs should display in this manner if there is no device attached:

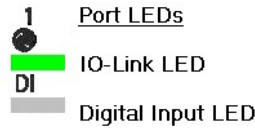

- IO-Link port LED should be flashing green indicating that it is searching for an IO-Link device.
- DI should be off to indicate that there is no device attached to the port.

If the LEDs indicate that you are ready to go to the next installation step:

- Program the IP address using the web interface. Refer to Chapter 3. Initial Configuration for configuring the network information.
- If using the rotary switches to set the IP address, then you are ready to attach devices using Chapter 5. Connecting Devices.

If the LEDs do not meet the above conditions, you can refer to the *IO-Link Master LEDs* table in the Troubleshooting and Technical Support chapter.

2.3.2 MD 258i-12-8K/L4-2R2K - Connecting the Power

The MD 258i-12-8K/L4-2R2K provides two redundant power inputs with screw terminals on the top and bottom of the unit.

Note: Use either power terminal (top or bottom) but **DO NOT** use both to supply power to the IO-Link Master.

Signal	Description
V-	24VDC Power Supply Return
V-	24VDC Power Supply Return
V+	Primary +24VDC Supply
V+	Secondary +24VDC Supply



Power Supply	Values
Power Supply In V+	4A (Maximum) *
IO-Link Connectors Ports 1 - 8 C/Q L+	200 mA (Maximum) 200 mA (Maximum)
Digital IO (D1 and D2 D3 and D4) D2, D4 L+	200 mA (Maximum) 200 mA (Maximum)
IO-Link Master Power	100mA @ 24VDC (V _S)
Power Supply Out	
<p>* The sum of the following must not exceed V+ maximum input current:</p> <ul style="list-style-type: none"> • IO-Link Mode module power • Actual C/Q current for each IO-Link port and for D2 and D4 output • Actual U_S current for each IO-Link port 	

You can use this procedure to connect the IO-Link Master to a power supply.

Note: Power should be disconnected from the power supply before connecting it to the IO-Link Master. Otherwise, your screwdriver blade can inadvertently short your terminal connections to the grounded enclosure.

1. Insert positive and negative wires (12-24AWG) into the V+ and V- contacts.

Note: Use either power terminal (top or bottom) but **DO NOT** use both to supply power to the IO-Link Master.
2. Tighten the wire-clamp screws to prevent the wires from coming loose.
3. Apply the power and verify that the following LEDs are lit indicating that you are ready to program the IP address and then attach your IO-Link or digital I/O devices.
 - **PWR** - green lit LED indicates the MD 258i-12-8K/L4-2R2K is receiving power.
 - **MS**, first the flashing green and red LEDs display that it is in self-test mode. After the self-test mode, depending on whether you set the IP address with the rotary switch one of the following occurs.
 - The green LED is flashing to indicate that the IO-Link Master is in standby mode.
 - The green LED is lit to indicate that the IO-Link Master is operational.
 - **NS**, first it flashes green and red indicating that it is in self-test mode. After self-test mode, depending on whether you set the IP address with the rotary switch one of the following occurs:
 - Off indicates there is no IP address.
 - Steady red indicates a duplicate IP address on the network.
 - **LINK** should be lit (green) to indicate a valid network connection.
 - **ACT** blinks if there is network traffic between the IO-Link Master and the network.
 - **EIP 1/2** should be lit (green) indicating that the link is up if both connectors are connected.
 - Port LEDs should display in this manner if there is no device attached:
 - IO-Link port LED should be flashing green indicating that it is searching for an IO-Link device.
 - **DI** should be off to indicate that there is no device attached to the port.

If the LEDs indicate that you are ready to go to the next installation step, Refer to Chapter 3. Initial Configuration to configure the network information.

If the LEDs do not meet the above conditions, you can refer to the *IO-Link Master LEDs* table in the Troubleshooting and Technical Support chapter.

2.4 Mounting the IO-Link Master

Use the appropriate procedure for your IO-Link Master hardware type.

2.4.1 MD 758i-11-42/L5-2222 - Mounting

Use the following procedure to mount the IO-Link Master. You can mount the IO-Link Master on a mounting panel or a machine.

1. Verify that the mounting surface is level (flat) to prevent mechanical stress to the IO-Link Master.
2. Attach the IO-Link Master to the surface with two 6mm screws and washers, torque down to 8Nm.

Note: You may want to connect the IO-Link devices before attaching the MD 258i-12-8K/L4-2R2K to the DIN rail. Use Chapter 5. Connecting Devices if you require IO-Link cabling information.

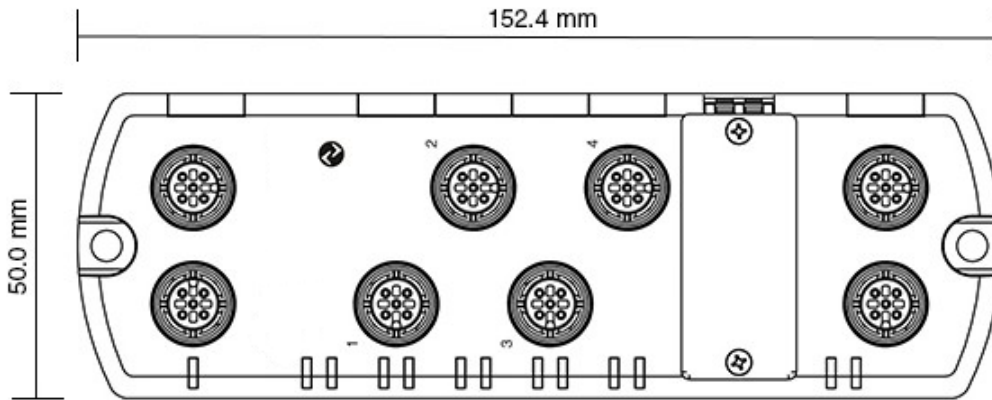

2.4.2 MD 258i-12-8K/L4-2R2K - Mounting

You may want to mount the IO-Link Master after programming the IP address and connecting the IO-Link and digital input/output devices.

1. Slide the metal latch down, hook the top of MD 258i-12-8K/L4-2R2K to the DIN rail and release the latch.
2. Verify that is tightly mounted.

Note: You may want to connect the IO-Link devices before attaching the MD 258i-12-8K/L4-2R2K to the DIN rail. Use Chapter 5. Connecting Devices if you require IO-Link cabling information.

3 Initial Configuration

The following topics are discussed in this chapter.

- Using the Web Interface to Program the Network, see Chapter 3.1
- Setting User Accounts and Passwords, see Chapter 3.2
- Configuring Miscellaneous Settings, see Chapter 3.3

3.1 Using the Web Interface to Program the Network

This chapter discusses using the web interface to configure the IP address. The default IP address is **192.168.60.101** and the Subnet Mask is: **255.255.255.0**.

Note: The rotary switch settings (applicable models) override the lower 3 digits (8 bits) of static IP address configured on the Configuration | Network page. The default rotary switch setting uses the settings configured in the flash.

Optionally, you can use the web interface to configure the upper 9 digits (24 bits) and the rotary switch to configure the lower 3 digits (8 bits) of the static IP address. You can also refer to Chapter 2.1 Setting the Rotary Switch (IP67 Model) for additional information.

You may need to change your host system IP address so that it can communicate with the IO-Link Master default IP address: 192.168.60.101.

The IO-Link Master is shipped from the factory with the Admin account enabled without a password. You can configure the Admin, Operator, and User passwords in Chapter 3.2.

1. Click **Configuration | NETWORK**.
2. Click the **EDIT** button.

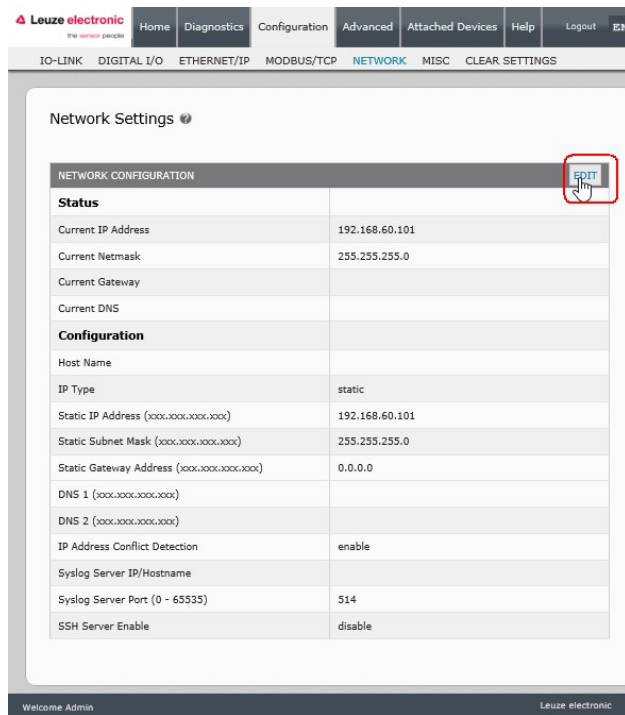

Figure 1: Web Network Configuration Page: Edit Network Settings

3. Click the **CONTINUE** button.

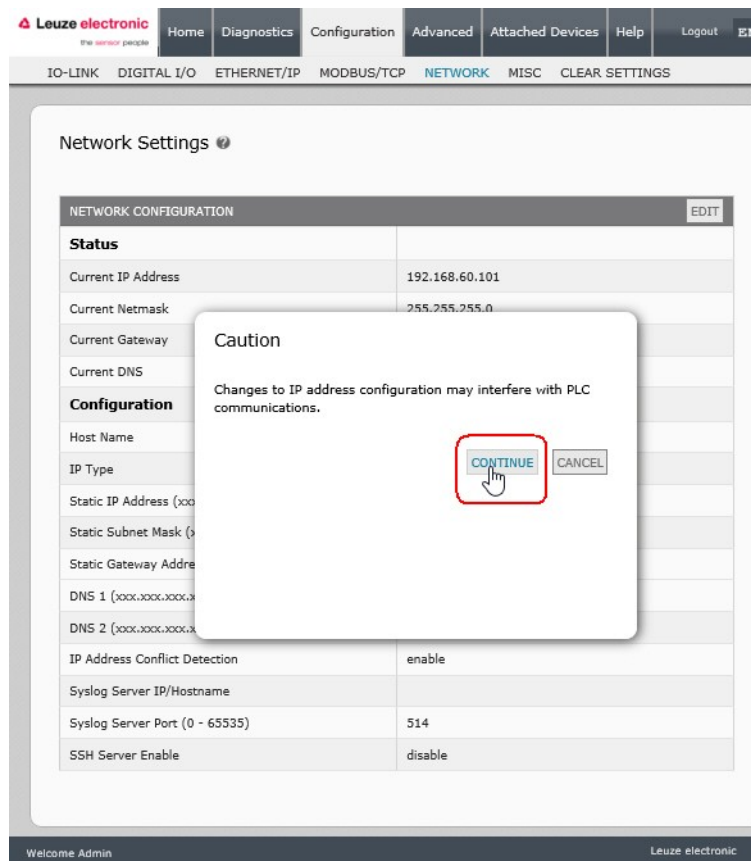

Figure 2: Web Network Configuration Page: IP address configuration

4. Optionally, enter a host name to identify this IO-Link Master.
5. Select the IP type, **Static** or **DHCP**.
 - If using a static IP address, enter the static IP address, subnet mask and IP gateway address.
 - If using DNS:
 - Enter the DNS primary server IP address.
 - Optionally, enter the DNS secondary server IP address.
6. If you want the IO-Link Master to send syslog messages to a syslog server:
 - a. Enter the syslog server's IP address (or host name if using DNS).
 - b. Enter the syslog server's port number (default is 514).
7. If you want to enable the SSH server, click **Enable**.
8. Click **SAVE** to save the changes.

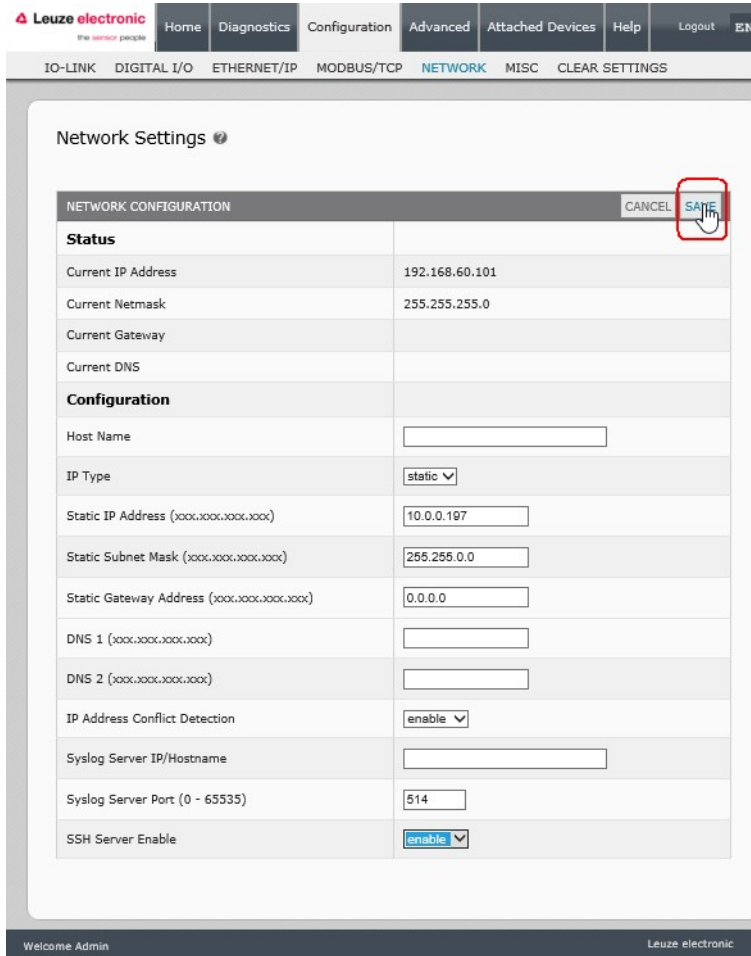

Figure 3: Web Network Configuration Page: static setting

9. If the IO-Link Master does not redirect you to the new page, open a session using the new IP address.

You should verify that you have the latest software installed on the IO-Link Master and if necessary, update the software. Refer to Chapter 4. Updating Images and Applications for information about locating the latest files and uploading the software.

After verifying that you have the latest software, you are ready to configure the IO-Link Master port characteristics.

3.2 Setting User Accounts and Passwords

The IO-Link Master is shipped from the factory without passwords. See the following table if you want to see how permissions are granted.

Page	Admin	Operator	User
Log-in	Yes	Yes	Yes
Home	Yes	Yes	Yes
Diagnostics - All	Yes	Yes	Yes
Configuration - IO-Link Settings	Yes	Yes	View-only
Configuration - Digital I/O Settings (Applicable models)	Yes	Yes	View-only
Configuration - EtherNet/IP Settings	Yes	Yes	View-only
Configuration - Modbus/TCP	Yes	Yes	View-only
Configuration - Network	Yes	View-only	No
Configuration - Misc	Yes	Yes	Yes
Configuration - Clear Settings	Yes	No	No
Advanced - Software	Yes	No	No
Advanced - Accounts	Yes	No	No
Advanced - Log Files	Yes	Yes	Yes
Advanced - Licenses	Yes	Yes	Yes
Attached Devices - IO-Link Device Description Files	Yes	Yes	View-only
Attached Devices - IO-Link Device Configuration Summary	Yes	Yes	View-only
Attached Devices - IO-Link Device - Port	Yes	Yes	View-only

You can use this procedure to set up passwords for the IO-Link Master.

1. Open your browser and enter the IO-Link Master IP address.
2. Click **Advanced | ACCOUNTS**.

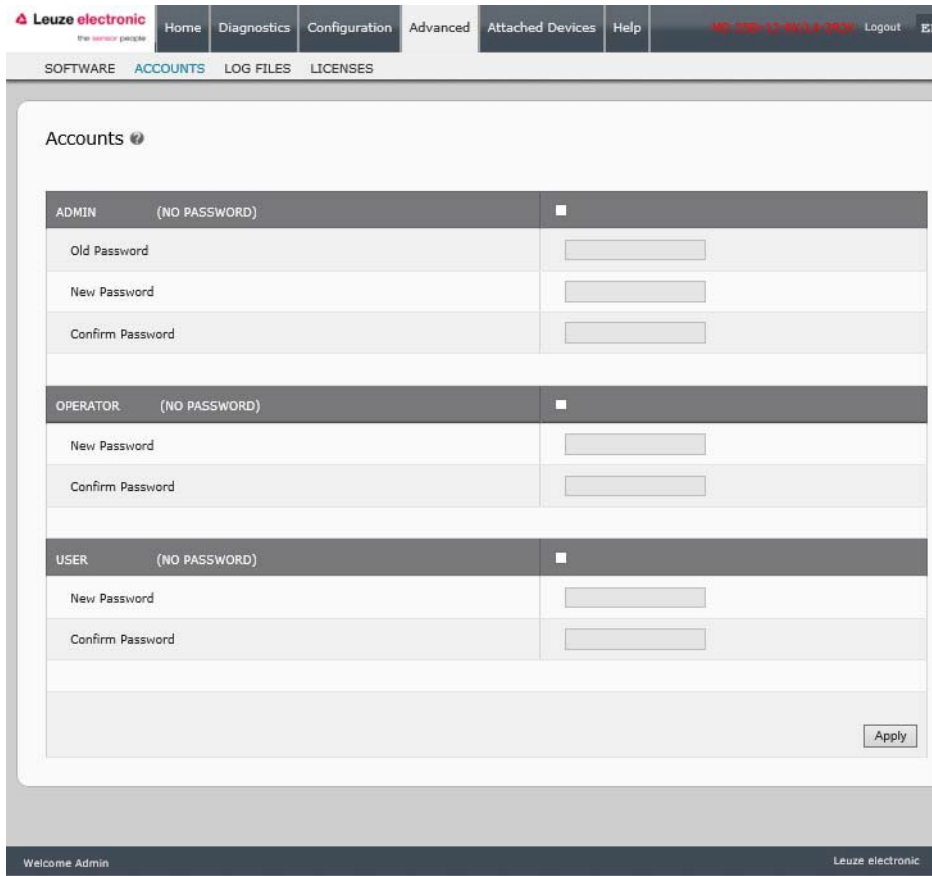

Figure 4: Advanced | ACCOUNTS

3. Click the **ADMIN** check box.
4. If applicable, enter the old password in the **Old Password** text box.
5. Enter the new password in the **New Password** text box.
6. Re-enter the password in the **Confirm Password** text box.
7. Optionally, click the **Operator** check box, enter a new password, and re-enter the password in the **Confirm Password** text box.
8. Optionally, click the **User** check box, enter the new password, and re-enter the password in the **Confirm Password** text box.
9. Click **Apply**.

10. Close the new window that displays a *Password saved* banner.

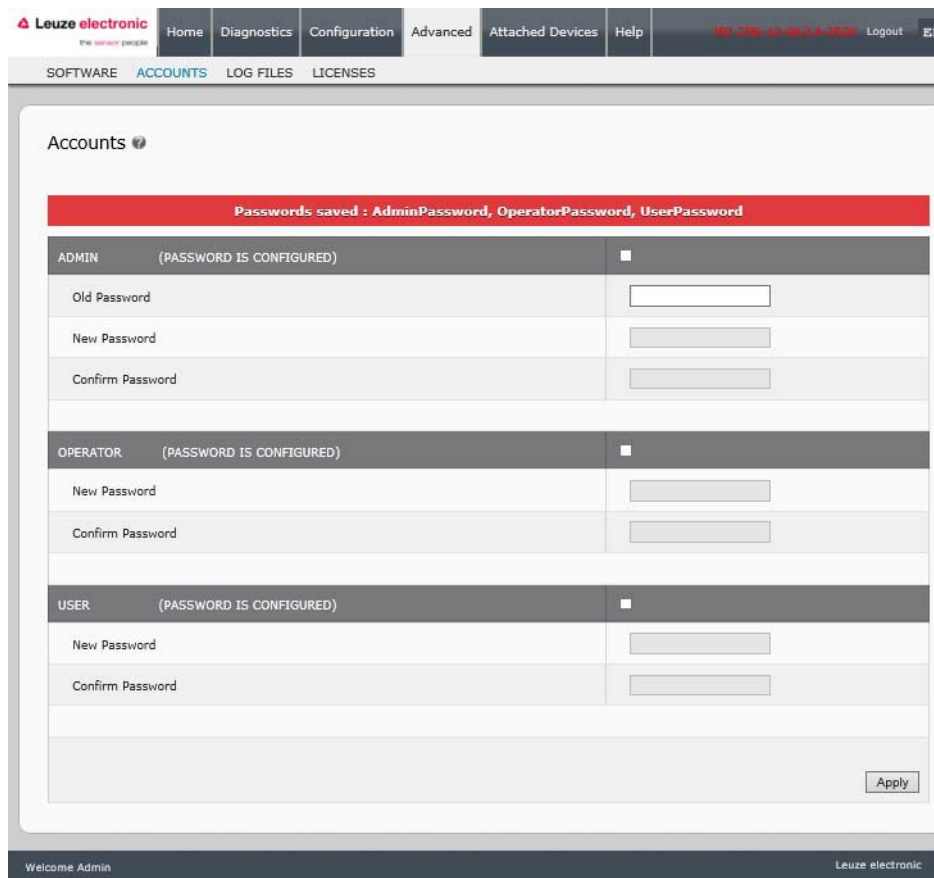

Figure 5: Confirm Password

11. Click the **Log out** button on the top navigation bar.

12. Re-open the web interface by selecting the appropriate user type in the drop list and entering the password.

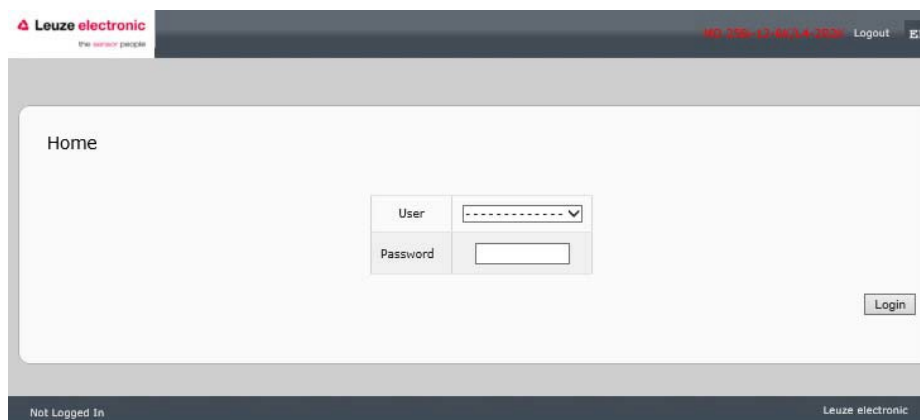

Figure 6: Login

3.3 Configuring Miscellaneous Settings

The **Miscellaneous Settings** page includes these options:

- **Menu Bar Hover Shows Submenu**

This option displays sub-menus for a category when you hover over the category name.

For example, if you hover over **Advanced**, the **SOFTWARE**, **ACCOUNTS**, **LOG FILES**, and **LICENSES** sub- menus display. You can click any submenu and avoid opening the default menu for a category.

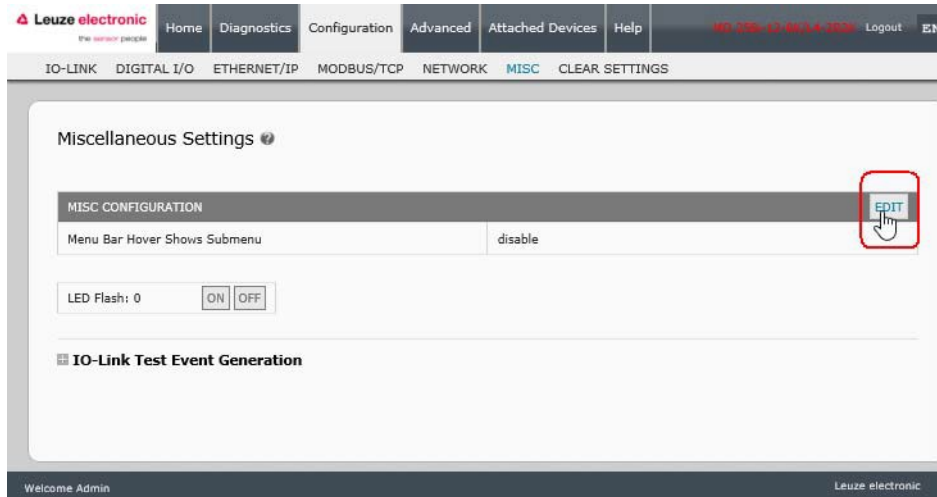

Figure 7: Configuring Miscellaneous Settings

- **LED Flash**

You can force the IO-Link port LEDs on the IO-Link Master into a flashing tracker pattern that allows you to easily identify a particular unit.

- Click the **ON** button to enable the LED tracker feature on the IO-Link Master. The LEDs remain flashing until you disable the LED tracker feature
- Click the **OFF** button to disable the LED tracker.

4 Updating Images and Applications

This chapter provides an overview of the software (images and applications) on the IO-Link Master. In addition it contains procedures to update images (Page 26) and application subassemblies (Page 27).

After verifying that the IO-Link Master contains the latest software, the next step is to configure the port characteristics using Chapter 6. IO-Link Port Configuration and/or Chapter 7. Dedicated Digital I/O Port Configuration on (on applicable models).

4.1 Images and Application Subassemblies Overview

The IO-Link Master is loaded with the latest images at the factory but you may need to update images or application subassemblies to have access to the latest features.

You can view all image and application versions in the IO-Link Master **ADVANCED | Software** page.

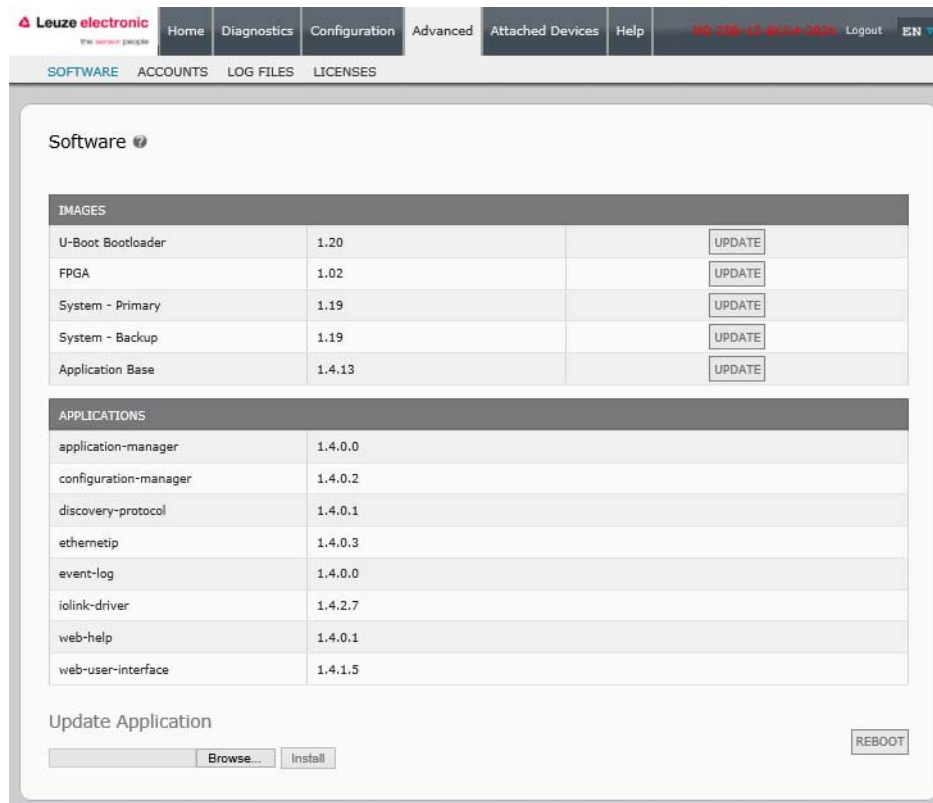

Figure 8: Images and Application Subassemblies Overview

4.1.1 Images

The following table discusses IO-Link Master images.

IO-Link Master Images	
U-Boot Bootloader	U-Boot is a high-level Bootloader that has networking and console command line capabilities. Among other things, it implements a TFTP server and Leuze electronic Corporation's new discovery protocol. This verifies that a Linux kernel image exists in NAND, then copies it to RAM and starts the IO-Link Master. The U-Boot version is displayed after the image name.
FPGA	The FPGA partition/image contains configuration data used by programmable hardware within the IO-Link Master unit.FPGA images are unique to the hardware and protocol type. Make sure you download the correct image for your platform.
ulmage - Primary/ Backup	The ulmage contains the Linux kernel and the RAM-resident root file system. It does not contain industrial protocol support or application-specific features. There is a Primary and Backup version loaded on the IO-Link Master. The IO-Link Master automatically reloads the Backup ulmage if the file system corrupted. The ulmage version is displayed after the Primary/Backup ulmage.
Application Base	The Application Base image comprises a flash-resident file system containing applications and protocol support. The Application Base is built from a collection of application subassemblies -- each of which may be updated individually between releases of the application base as a whole. The application subassemblies in the Application Base image are displayed in the lower portion of the SOFTWARE page. The Application Base assembly has a 3-tuple version number: (for example, 1.3.18).

4.1.2 Application Subassemblies

Application subassemblies are the components of the Application Base image. Application subassemblies have a 4-tuple version number (for example, 1.3.18.3). The first two values in a subassembly version correspond to the version of the application base assembly for which it was built and tested.

For example, a subassembly with version 1.3.18.3 was tested with application base version 1.3.18. When using the **Software** page, an application subassembly can install only if its version number matches that of the installed application base assembly. A subassembly with a version of 1.20.2.4 only installs if the application base version is 1.20.2. It will not install on a device with application base version 1.21.5.

IO-Link Master Application Subassemblies	
application-manager	The Application Manager version loaded on the IO-Link Master.
configuration-manager	The Configuration Manager version loaded on the IO-Link Master.
discovery-protocol	The Discovery Protocol version loaded on the IO-Link Master.
ethernetip	The EtherNet/IP and Modbus/TCP interfaces version loaded on the IO-Link Master.
event-log	The Event log version loaded on the IO-Link Master.
iolink-driver	The IO-Link driver version loaded on the IO-Link Master.
web-help	The web interface help version loaded on the IO-Link Master.
web-user-interface	The web interface version loaded on the IO-Link Master.

4.2 Using the Web Interface to Update Software

The upper portion of the **Advanced | Software** page is used to update the IO-Link Master images. The lower portion of this page is used for updating application subassemblies that are integrated in the Application Base.

Typically, the latest application subassemblies are available in the Application Base image. There may times when a feature enhancement or bug fix is available in an application subassembly and not yet available in the Application Base image.

4.2.1 Updating Images

Use this procedure to upload images using the **SOFTWARE** page.

1. Download the latest image from the Leuze electronic web site.
 - Note: Make sure that you download the appropriate software for your model. For example, the FPGA images are unique for different hardware models and protocol.*
2. Open your browser and enter the IP address of the IO-Link Master.
3. Click **Advanced | SOFTWARE**.
4. Click the **UPDATE** button next to the image you want to update.
5. Click the **Browse** button, navigate to the file location, highlight the image, and click **Open**.
6. Click the **Install** button.

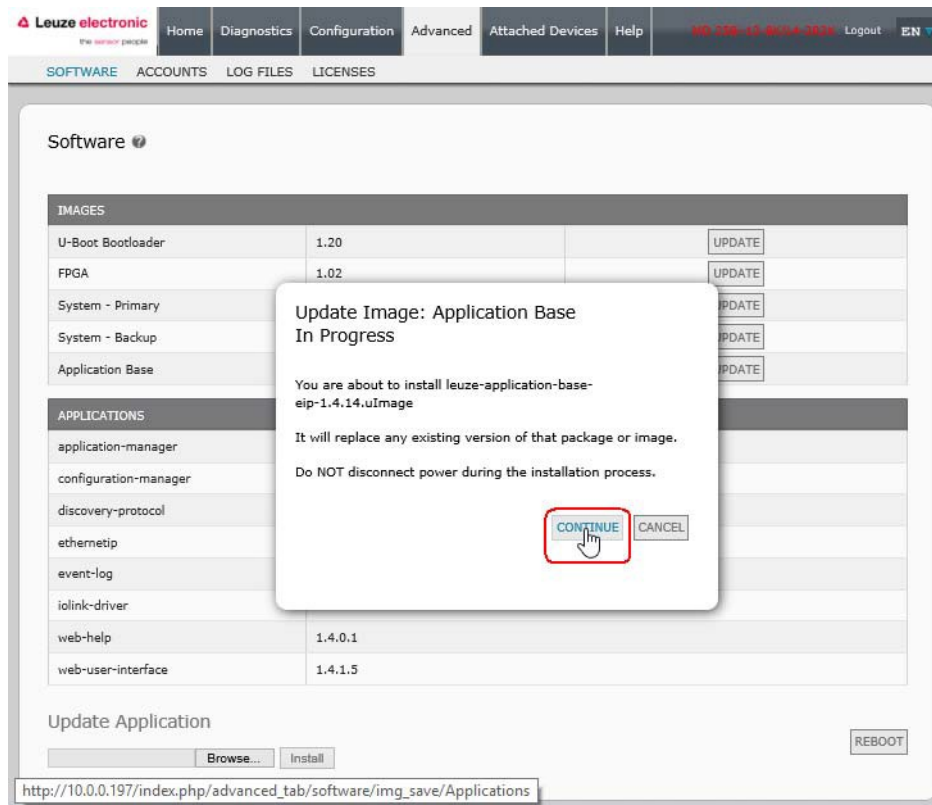

Figure 9: Updating Images

7. Click the **CONTINUE** button to the Update Image message.
8. Click **OK** to close the Update Image Successful message.
 - Note: Some images may require the IO-Link Master web server to restart.*

4.2.2 Updating Application Subassemblies

Use this procedure to upload applications using the **Software** page.

1. Download the latest application from the Leuze electronic web site.
2. Open your browser and enter the IP address of the IO-Link Master.
3. Click Advanced and SOFTWARE.
4. Click the Browse button under Update Application navigate to the file location, highlight the application, and click Open.
5. Click the Install button.
6. Click the **CONTINUE** button to the *Update Application* message.

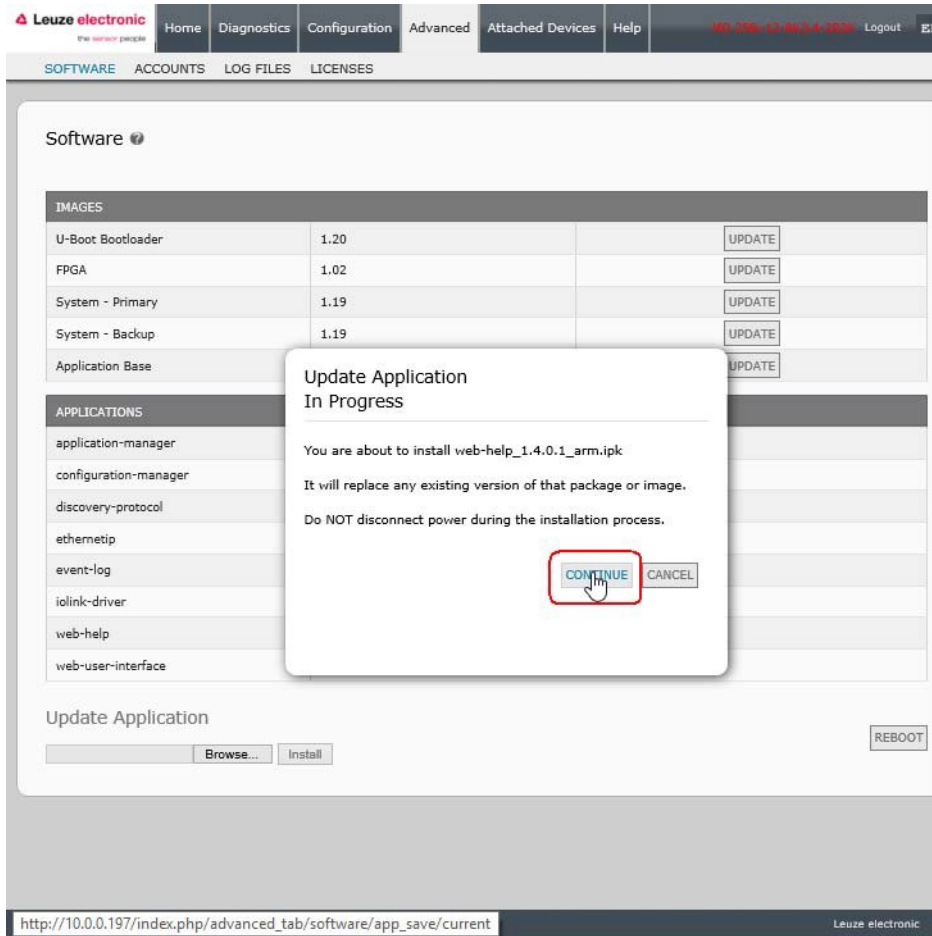

Figure 10: Updating Application Subassemblies

7. Click **OK** to close the *Update Application Successful* message.

5 Connecting Devices

This chapter discusses connecting devices to the IO-Link Master.

5.1 Connecting Devices to IO-Link Ports

Use the appropriate discussion for your IO-Link Master model.

- *MD 758i-11-42/L5-2222 IO-Link Ports, see Chapter 5.1.1*
- *MD 258i-12-8K/L4-2R2K IO-Link Ports, see Chapter 5.1.2*

5.1.1 MD 758i-11-42/L5-2222 IO-Link Ports

The MD 758i-11-42/L5-2222 provides four IO-Link ports (depending on the model) with M12, 5-pin female/A coded connectors.

This table provides signal information for the IO-Link connectors.

Pin	Signal	Description
1	L+	Power supply (+)
2	DI	Digital input
3	L-	Power supply (-)
4	C/Q	Communication signal, which supports SDCI (IO-Link) or SIO (standard input/output)
5	N/A	Not connected

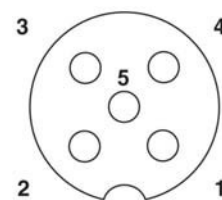

The standard SDCI (IO-Link) transmission rates are supported:

- COM1 4.8Kbps
- COM2 38.4Kbps
- COM3 230.4Kbps

This table provides current and power information that you may need regarding the IO-Link ports.

Current and Power	MD 758i-11-42/ L5-2222
Maximum C/Q Current	200mA
Maximum L+/L- Current Output	500mA
C/Q & DI Input:	Power Input
Maximum (L+)	+0.5VDC
Minimum (L-)	-0.5VDC

Use the following procedure to attach IO-Link or digital input/output devices to the ports.

1. Securely attach the IO-link cable between the IO-Link or digital input/output device and the IO-Link port.

Note: *Make sure that you tighten the cables properly to maintain IP67 integrity.*

2. If necessary, securely attach a connector cap to prevent dust or liquids from getting into any unused ports. Connector caps were shipped with the IO-Link Master.

Note: *IO-Link ports must have an approved cable or protective cover attached to the port to guarantee IP67 compliance.*

3. If necessary, configure IO-Link port parameters using the **Configuration | IO-Link Settings** page to configure the port mode.
 - If an IO-Link device is attached to the port, the IO-Link LED should now be lit green and the device is receiving power.
 - If a digital input or output device is attached to the IO-Link port, after the port is configured for digital input or output on the **IO-Link Settings** page, the IO-Link LED does not light but when an event occurs:
 - Digital input causes the DI LED to flash.
 - Digital output causes the IO-Link LED to flash

You can refer to the help system or 6.2. IO-Link Configuration Page for configuration information.

5.1.2 MD 258i-12-8K/L4-2R2K IO-Link Ports

The following provides information about the IO-Link ports.

Label	Signal	Description	Value
1	L+	Power Supply Output (+)	200mA @ 24V (Maximum)
2	L-	Power Supply Output (-)	
3	DI	Digital Input	Not applicable.
4	C/Q	Communication signal, which supports SDCI (IO-Link) or SIO (standard input/output)	200mA @ 24V (Maximum)

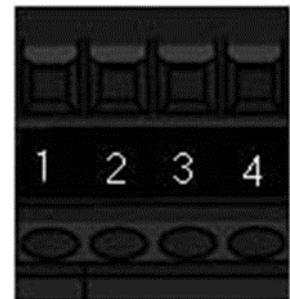

Use the appropriate procedure to connect devices to the IO-Link ports.

- *Connecting IO-Link Devices, see Chapter 5.1.2.2*
- *Connecting Digital Input Devices to IO-Link Ports, see Chapter 5.1.2.3*

5.1.2.1 Tips When Connecting Devices to the MD 258i-12-8K/L4-2R2K

The following tips may be useful when connecting devices to the MD 258i-12-8K/L4-2R2K because it may be difficult to manipulate the wire-clamp screws on the adjacent ports.

- If you are going to connect devices to Digital I/O ports (**D1** through **D4**), connect the digital devices before connecting devices to IO-Link ports.
- Connect a device to IO-Link Port 1 before IO-Link Port 2
- Connect a device to IO-Link Port 4 before IO-Link Port 3
- Connect a device to IO-Link Port 5 before IO-Link Port 6
- Connect a device to IO-Link Port 8 before IO-Link Port 7

5.1.2.2 Connecting IO-Link Devices

Use the following procedure to connect IO-Link devices to the IO-Link ports.

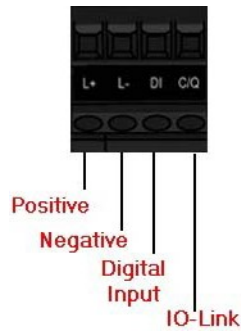

1. Insert the IO-Link device negative wire into the **L-** contact and tighten the wire-clamp screws to prevent the wire from coming loose.
2. Insert the IO-Link device positive wire into the **L+** contact and tighten the wire-clamp screws to prevent the wire from coming loose.
3. If applicable, insert the DI wire into the **DI** contact and tighten the wire-clamp screws to prevent the wire from coming loose.
4. Insert the IO-Link wire into the **C/Q** contact and tighten the wire-clamp screws to prevent the wire from coming loose.
5. If necessary, configure IO-Link parameters for each port. Refer to Chapter 6.1 Preparing for Port Configuration or the help system for detailed port configuration information.

5.1.2.3 Connecting Digital Input Devices to IO-Link Ports

You can use an IO-Link port as a digital in port if you wish to do so.

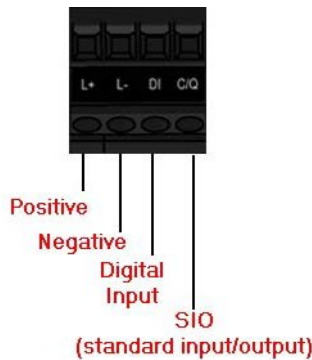

1. Insert the IO-Link device negative wire into the **L-** contact and tighten the wire-clamp screws to prevent the wire from coming loose.
2. Insert the IO-Link device positive wire into the **L+** contact and tighten the wire-clamp screws to prevent the wire from coming loose.
3. If applicable, insert the DI wire into the **DI** contact and tighten the wire-clamp screws to prevent the wire from coming loose.
4. Refer to the help system for detailed port configuration information.

5.1.2.4 Connecting DIO Devices to IO-Link Ports

You can use an IO-Link port to connect and operate a digital input or output device.

1. Insert the IO-Link device negative wire into the **L-** contact and tighten the wire-clamp screws to prevent the wire from coming loose.
2. Insert the IO-Link device positive wire into the **L+** contact and tighten the wire-clamp screws to prevent the wire from coming loose.
3. If applicable, insert the DI or DO wire into the **C/Q** contact and tighten the wire-clamp screws to prevent the wire from coming loose.
4. Refer to the help system for detailed port configuration information.

5.2 Connecting Devices to the Digital IO Ports (MD 258i-12-8K/L4- 2R2K)

The MD 258i-12-8K/L4-2R2K provides two digital input (DI) ports and two digital IO ports.

Label	Signal	Description	Specifications
1	L+	Power Supply (+)	200mA @ 24V (maximum)
2	L-	Power Supply (-)	
3	DI	Digital Input	
4	DIO	Digital I/O	200mA @ 24V (maximum)

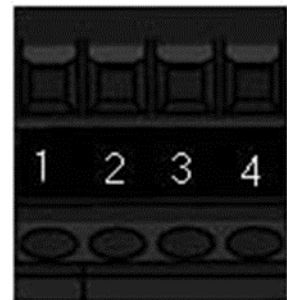

Note: Depending on your model, the terminal blocks maybe labeled numerically or with the signal abbreviations.

You can connect a digital input device to DI and/or DIO. DIO supports digital out.

5.2.1 Connecting to DI

Use this procedure to connect a digital input device using the **DI** terminal on a DIO port.



↑
D1 or D3
LEDs

1. Insert the IO-Link device negative wire into the **L-** contact and tighten the wire-clamp screws to prevent the wire from coming loose.
2. Insert the IO-Link device positive wire into the **L+** contact and tighten the wire-clamp screws to prevent the wire from coming loose.
3. Insert the DI wire into the **DI** contact and tighten the wire-clamp screws to prevent the wire from coming loose.
4. Go to the **Configuration | Digital I/O Settings** page to configure the port. If necessary, refer to the help system or 6.2 IO-Link Configuration Page.

5.2.2 Connecting to DIO



1. Insert the IO-Link device negative wire into the **L-** contact and tighten the wire-clamp screws to prevent the wire from coming loose.
2. Insert the IO-Link device positive wire into the **L+** contact and tighten the wire-clamp screws to prevent the wire from coming loose.
3. Insert the DI wire into the **DI** contact and tighten the wire-clamp screws to prevent the wire from coming loose.
4. Go to the **Configuration | Digital I/O Settings** page to configure the port. If necessary, refer to the help system or Chapter 7. Dedicated Digital I/O Port Configuration.

6 IO-Link Port Configuration

This chapter discusses port configuration, which includes these topics:

- *Preparing for Port Configuration, see Chapter 6.1*
- *IO-Link Configuration Page, see Chapter 6.2*
- *EtherNet/IP Settings Configuration Page, see Chapter 6.3*
- *Modbus/TCP Settings Configuration Page, see Chapter 6.3*

Note: See Chapter 7. *Dedicated Digital I/O Port Configuration* for information about configuring dedicated digital I/O ports (MD 258i-12-8K/L4-2R2K).

Depending on your environment, the IO-Link Master you may not need to change many of the default options.

6.1 Preparing for Port Configuration

Before beginning port configuration, you may want to verify that the connected device is functioning.

1. If necessary, log into the IO-Link Master.
2. Click **Diagnostics| IO-Link Diagnostics**.
3. Review the **Port Status** and **IOLink State**.

Port Status	Operational, PDI Valid	An IO-Link device is operating on the port that has received valid PDI data.
	Operational	An IO-Link device is operating on the port that has not received valid PDI data.
	Inactive	One of the following conditions exists: <ul style="list-style-type: none"> • A valid IO-Link device is not connected to the port. • A digital input or output device is connected to the port but the configured Port Mode is not correct.
IOLink State	Operate	Port is functioning correctly in IO-Link mode but has not received valid PDI data. This may also display during a data storage upload or download.
	Init	The port is attempting initialization.
	Reset	One of the following conditions exists: <ul style="list-style-type: none"> • The Port Mode configuration is set to Reset. • The Port Mode configuration is set to DigitalIn or DigitalOut.
	DS: Wrong Sensor	Hardware failure (IO-Link LED also flashes red) because there is Data Storage on this port, which does not reflect the attached device.
	DV: Wrong Sensor	Hardware failure (IO-Link LED also flashes red) because Device Validation is configured for this port and the wrong device is attached.
	DS: Wrong Size	Hardware failure (IO-Link LED also flashes red) because the size of the configuration on the device does not match the size of the configuration stored on the port.
	Comm Lost	Temporary state after a device is disconnected and before the port is re-initialized.
Pre-operate	Temporary status displayed when the device: <ul style="list-style-type: none"> • Is starting up after connection or power-up. • Uploading or downloading automatic data storage. 	

Note: If a digital input or output device is connected to an IO-Link port, there is no valid data until the port is set to the correct **Port Mode**.

4. Review the **Device IO-Link Version**.
 - If the field is blank, it is not a valid IO-Link device, which could mean that it is a digital device and the port has not been configured for digital input or digital output.
 - The field displays the Device IO-Link version.
5. Optionally, review the following to see if you need to change the **Configured Minimum Cycle Time**:
 - **Actual Cycle Time**
 - **Device Minimum Cycle Time**
 - **Configured Minimum Cycle Time**

The **Configured Minimum Cycle Time** is the minimum cycle time that the IO-Link Master allows the port to operate at. The **Actual Cycle Time** is negotiated between the IO-Link Master and the device and will be at least as long as the greater of the **Configured Minimum Cycle Time** and the **Device Minimum Cycle Time**.

6. Verify that the **Auxiliary Input Bit Status** field displays **On**, if the device is connected to DI (Pin 2 with M12 connectors).

IO-LINK PORT STATUS	PORT 1	PORT 2	PORT 3	PORT 4	PORT 5	PORT 6	PORT 7	PORT 8
Port Name	IOLink Port 1	IOLink Port 2	IOLink Port 3	IOLink Port 4	IOLink Port 5	IOLink Port 6	IOLink Port 7	IOLink Port 8
Port Mode	IOLink	IOLink	IOLink	IOLink	IOLink	IOLink	IOLink	IOLink
Port Status	Operational,PDI Valid	Operational,PDI Valid	Inactive	Inactive	Operational,PDI Valid	Inactive	Inactive	Inactive
IO-Link State	Operate	Operate	Init	Init	Operate	Init	Init	Init
Device Vendor Name	Leuze electronic GmbH + Co. KG	Leuze electronic GmbH + Co. KG			Leuze electronic GmbH + Co. KG			
Device Product Name	KRTL 3B/6.3111-58	HT10L1-25M.3/L69-M12			HRTR 46B/L4.23-S12			
Device Serial Number	1408L068197	01540018205			1111C000485			
Device Hardware Version	L	B000			C			
Device Firmware Version	02.20	1.1			01.15			
Device IO-Link Version	1.0	1.1			1.1			
Actual Cycle Time	4.0 ms	4.0 ms			0.0 ms			
Device Minimum Cycle Time	2.5 ms	2.3 ms			7.2 ms			
Configured Minimum Cycle Time	4 ms	4 ms	4 ms	4 ms	4 ms	4 ms	4 ms	4 ms
Data Storage Capable	No	Yes			No			
Automatic Data Storage Configuration	Disabled	Disabled	Disabled	Disabled	Disabled	Disabled	Disabled	Disabled
Auxiliary Input (AI) Bit Status	Off	Off	Off	Off	On	Off	Off	Off
Device PDI Data Length	2	1			1			
PDI Data Valid	Yes	Yes			Yes			

Figure 11: IO-Link Diagnostics

Note: This image illustrates the MD 258i-12-8K/L4-2R2K, which provides dedicated digital I/O ports.

For additional information about the IO-Link Diagnostics page, see the help system or Chapter 11.1. IO-Link Port Diagnostics.

6.2 IO-Link Configuration Page

You can use the **Configuration | IO-Link Settings** page to configure IO-Link port settings. When the IO-Link device is attached to a port, it begins operating without requiring any configuration. The IO-Link Master and attached IO-Link device automatically negotiate the **Minimum Cycle Time**. If required by an application, you can set a specific **Minimum Cycle Time**.

This page provides special features such as Data Storage, Device Validation, and Data Validation.

Note: Do not configure Data Storage until the IO-Link device is configured. Data Storage, Device Validation, and Data Validation are discussed in Chapter 10. Utilizing IO-Link Master Features.

This chapter discusses:

- *Editing IO-Link Port Settings, see Chapter 6.2.1*
- *IO-Link Settings Parameters, see Chapter 6.2.2*

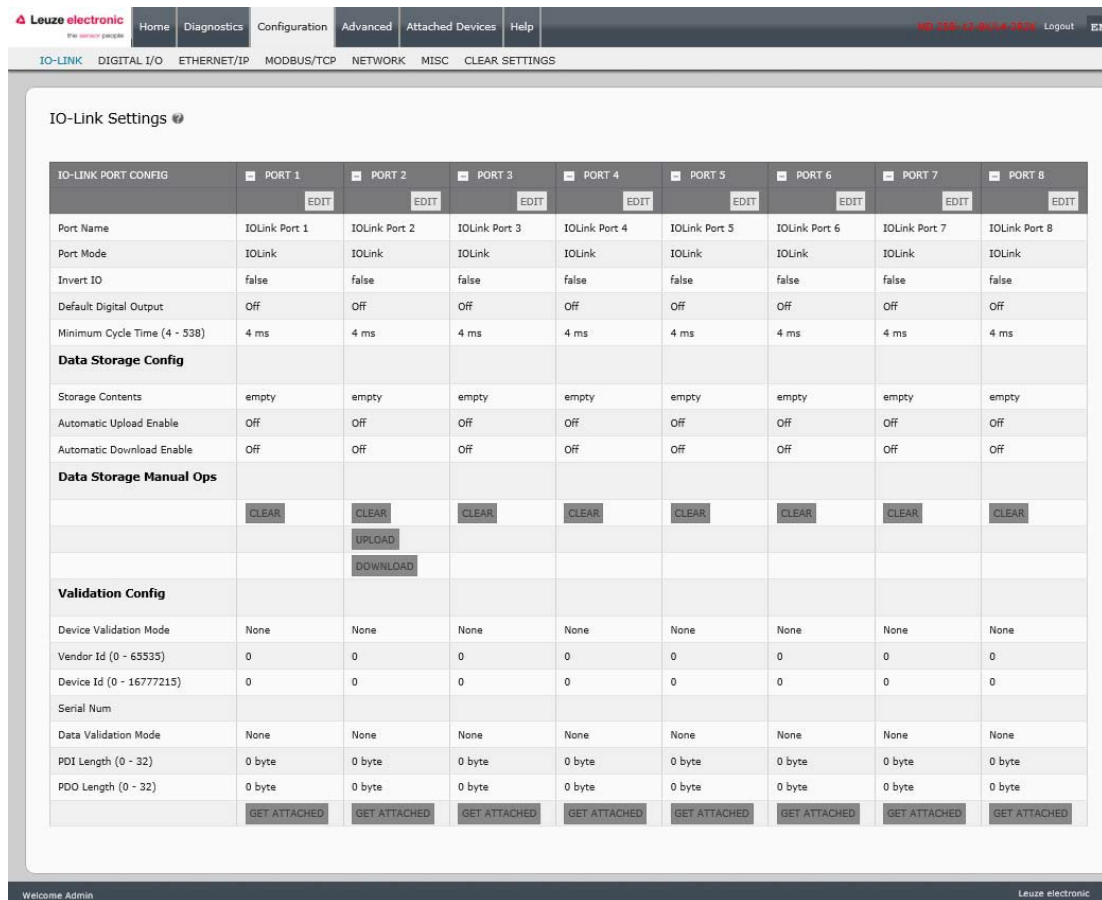

Figure 12: IO-Link Configuration Page

6.2.1 Editing IO-Link Port Settings

You can use this procedure to configure IO-Link settings for each IO-Link port.

If an IO-Link device is attached to the port, no configuration is required for operation. If a digital input or output device is attached, it is necessary to change the **Port Mode**.

1. If necessary, open the IO-Link Master web interface with your web browser using the IP address.
2. Click **Configuration | IO-Link Settings**.
3. Click the **EDIT** button for the port or ports that you want to configure.

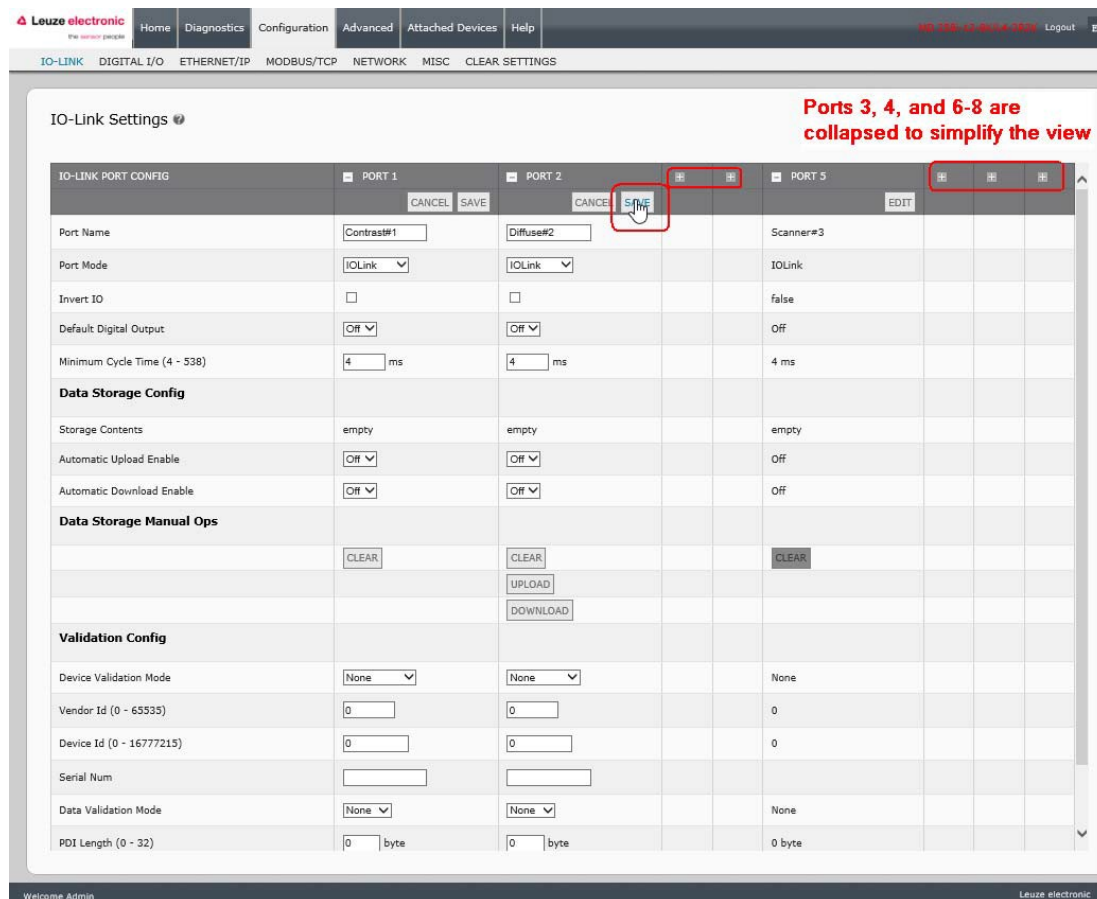

Figure 13: Editing IO-Link Port Settings

Note: You can click each **EDIT** button and open all ports to quickly configure port parameters.

4. Make appropriate selections for the device that you connected to that port. Make sure you select the **DigitalIn** option for a digital input device and the **DigitalOut** option for a digital output device for the **Port Mode**.

The IO-Link Master negotiates the **Minimum Cycle Time** so it is not necessary to set a cycle time unless you need a specific cycle time.

You can use the help system if you require definitions or values for the options or refer to the following subsection (IO-Link Settings Parameters).

Note: Do not configure **Data Storage** until the IO-Link device is configured.

Note: Do not enable **Automatic Download** and then attempt device configuration as **Automatic Download** changes the settings back to what is stored on the IO-Link Master. **Data Storage**, **Device Validation**, and **Data Validation** are discussed in Chapter 10. Utilizing IO-Link Master Features.

5. Click the **SAVE** button for each port.
6. Return to the **IO-Link Diagnostics** page to verify that your changes have taken affect.

6.2.2 IO-Link Settings Parameters

The **Configuration | IO-Link Settings** page supports the following options.

IO-LINK Settings Page	
Port Name	User defined port or device description. <ul style="list-style-type: none"> • Standard ASCII characters • Max length = 80 characters
Port Mode <i>Default: IO-Link</i>	Selected IO-Link port mode. Valid settings are: <ul style="list-style-type: none"> • Reset - Select to disable a port or to reset/restart an IO-Link port. • IO-Link - Select to connect and operate an IO-Link device on the port. • Digital In - Select if a DI device is attached to the port. • Digital Out - Select if a DO device is attached to the port.
Invert IO <i>Default: False</i>	If enabled and the Port Mode is Digital In or Digital Out, this option inverts the I/O value. <ul style="list-style-type: none"> • False (Disabled - Do not invert IO) • True (Enabled - Invert IO) <p><i>Note: This option does not affect the Auxiliary Input.</i></p>
Default Digital Output <i>Default: Off</i>	If the port mode is Digital Out , defines the default digital output value that is used at startup and when there is no active PDO controller. <ul style="list-style-type: none"> • Off (low voltage) - 0 • On (high voltage) - 24V
Minimum Cycle Time <i>Default: 4</i>	The minimum, or fastest, cycle time at which the IO-Link device may operate. The valid range is 4-538 ms. You can leave the Minimum Cycle Time set to the default value and the IO-Link Master negotiates with the IO-Link device for its minimum cycle time. The IO-Link Diagnostics page displays the Actual Cycle Time , which is the negotiated cycle time.

IO-LINK Settings Page	
Data Storage Config	
Storage Contents	<p>Indicates that the data storage for the port is empty or displays the Vendor ID and Product ID of the data stored on that port.</p>
Automatic Data Storage Upload Enable <i>Default: Off</i>	<p>When this option is initially set to On, the IO-Link Master saves the data storage (if the data storage is empty) from the IO-Link device to that port. Some IO-Link devices update the data storage contents if you use the Teach buttons on the IO-Link device, but that is determined by the IO-Link device manufacturer.</p> <p>Automatic upload occurs when the Automatic Upload Enable option is set to On and one of these conditions exists:</p> <ul style="list-style-type: none"> • There is no upload data stored on the gateway. • The IO-Link device executes a requests_ at upload function (generally because you have changed the configuration via Teach buttons). <p>Do not enable both Automatic Upload and Automatic Download at the same time, the results are not reliable among IO-Link device manufacturers.</p> <p>When a port contains data storage for an IO-Link device and if you attach a device whose Vendor and Device ID do not match, the IO-Link LED on the IO-Link Master flashes red to indicate a wrong device is attached. In addition, the IO-Link Diagnostics page displays DV: Wrong Sensor in the IOLink State field.</p> <p>You should not enable Automatic Upload until after you have configured the IO-Link device attached to the port unless you want to capture the default settings. Refer to 10.1. Data Storage for more information.</p>
Automatic Data Storage Download Enable <i>Default: Off</i>	<p>The data stored on the IO-Link Master port is downloaded to the IO-Link device if:</p> <ol style="list-style-type: none"> 1. This option is selected. 2. The data stored on the IO-Link Master port contains the same Vendor ID and Product ID as the IO-Link device connected to the port. 3. The data stored on the IO-Link Master port is different than that of the IO-Link device. 4. The IO-Link device requests an upload and the Automatic Upload Enable option is set to Off. <p>If you change configuration parameters on the IO-Link device and want the parameters to remain loaded on the IO-Link device, you must disable the Automatic Download option because otherwise the IO-Link Master will reload the data storage on the port down to the IO-Link device.</p> <p>Do not enable both Automatic Upload and Automatic Download at the same time, the results are not reliable among IO-Link device manufacturers.</p>
Data Storage Manual Ops	<p>The Manual Data Storage Ops option provides the following functionality, if data storage is supported by the IO-Link device.</p> <ul style="list-style-type: none"> • CLEAR - this clears any stored data for an IO-Link device on this port. • UPLOAD - this uploads and stores the IO-Link device configuration on the IO-Link Master. • DOWNLOAD - this downloads the stored IO-Link device configuration from the IO-Link Master to the IO-Link device attached to this port if the Vendor ID and Device ID match.

IO-LINK Settings Page	
Validation Config	
Device Validation Mode (Default: None)	<p>Device Validation Mode provides these options:</p> <ul style="list-style-type: none"> • None - this disables Device Validation Mode. • Compatible - permits a compatible IO-Link device (same Vendor ID and Device ID) to function on the corresponding port. • Identical - only permits an IO-Link device to function on the corresponding port as defined in the following fields. <ul style="list-style-type: none"> • Vendor ID • Device ID • Serial Number
Vendor Id (0-65535)	<p>This is required if you select a Device Validation Mode other than None.</p> <p>The Vendor ID can be manually entered in this field or click the GET ATTACHED button and the IO-Link Master propagates the Vendor ID in this field.</p>
Device Id (0-16777215)	<p>This is required if you select a Device Validation Mode other than None.</p> <p>The Device ID can be manually entered in this field or click the GET ATTACHED button and the IO-Link Master propagates the Device ID in this field.</p>
Serial Num	<p>This is required if you select Identical for the Device Validation Mode.</p> <p>The Serial Number can be manually entered in this field or click the GET ATTACHED button and the IO-Link Master propagates the serial number in this field.</p>
Data Validation Mode (Default: None)	<p>There are three Data Validation Modes:</p> <ul style="list-style-type: none"> • None - no data validation is performed on the port. • Loose - the slave device's PDI/PDO lengths must be less than or equal to the user-configured values. • Strict - the slave device's PDI/PDO lengths must be the same as the user-configured values.
PDI Length (0-32)	<p>This is input length of the PDI data field.</p> <p>This is required if you select a Data Validation Mode other than <i>None</i>.</p> <p>The PDI Length can be manually entered in this field or click the GET ATTACHED button and the IO-Link Master propagates the PDI length in this field.</p>
PDO Length (0-32)	<p>This is input length of the PDO data field.</p> <p>This is required if you select a Data Validation Mode other than None.</p> <p>The PDO Length can be manually entered in this field or click the GET ATTACHED button and the IO-Link Master propagates the PDO length in this field</p>
GET ATTACHED (Button)	<p>After opening a port for editing, you can click the GET ATTACHED button instead of manually entering data in the following fields:</p> <ul style="list-style-type: none"> • Vendor Id • Device Id • Serial Num • PDI Length • PDO Length

6.3 EtherNet/IP Settings Configuration Page

Use the **EtherNet/IP Settings** page to configure EtherNet/IP options. This chapter includes the following topics:

- *Editing EtherNet/IP Settings, see Chapter 6.3.1*
- *EtherNet/IP Settings Parameters, see Chapter 6.3.2*

Note: The IO-Link Master may work out of the box for ControlLogix PLCs

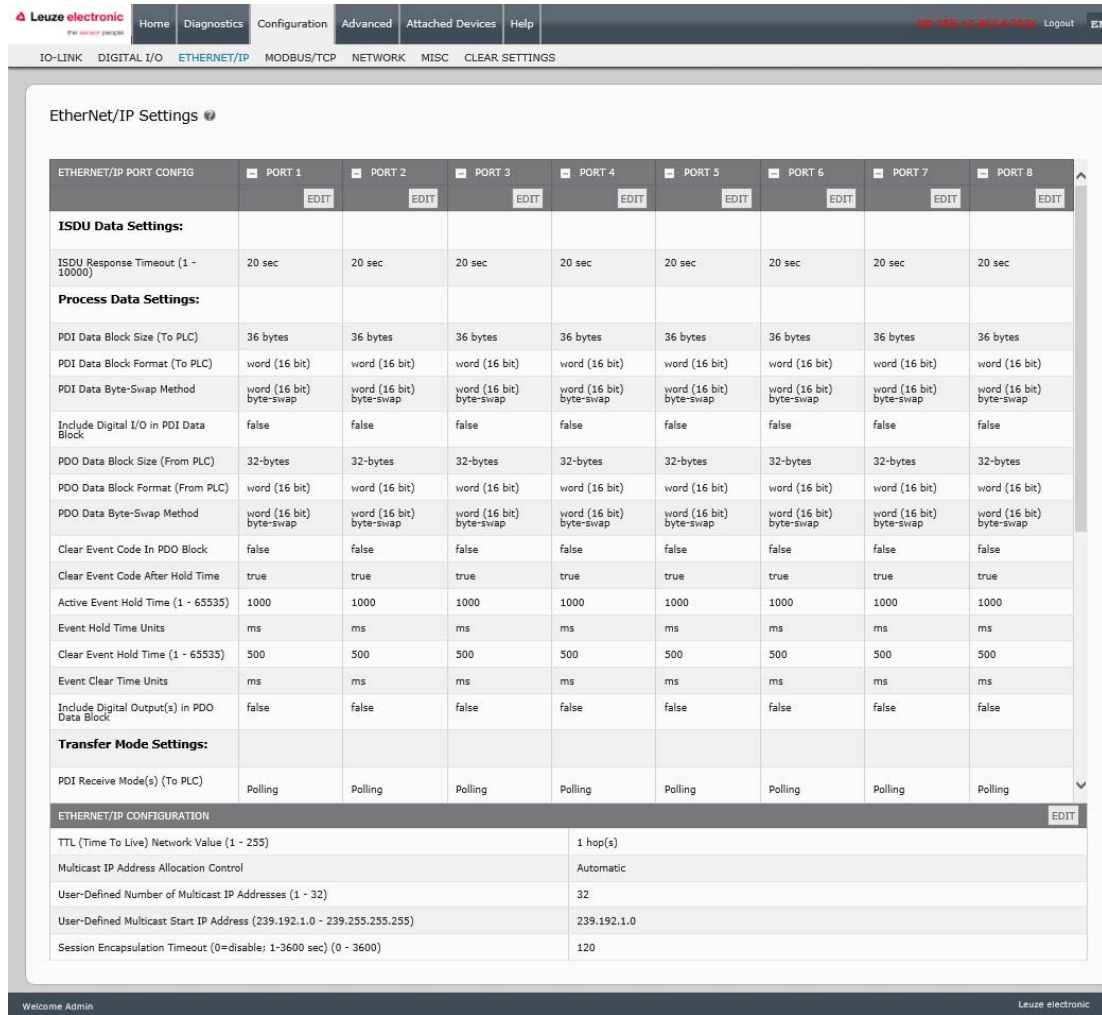

Figure 14: EtherNet/IP Settings Configuration Page

6.3.1 Editing EtherNet/IP Settings

You can use this procedure to configure EtherNet/IP characteristics for each port.

1. If necessary, open the IO-Link Master web interface with your web browser using the IP address.
2. Click **Configuration | EtherNet/IP**.
3. Click the **EDIT** button for each port that you want to configure.

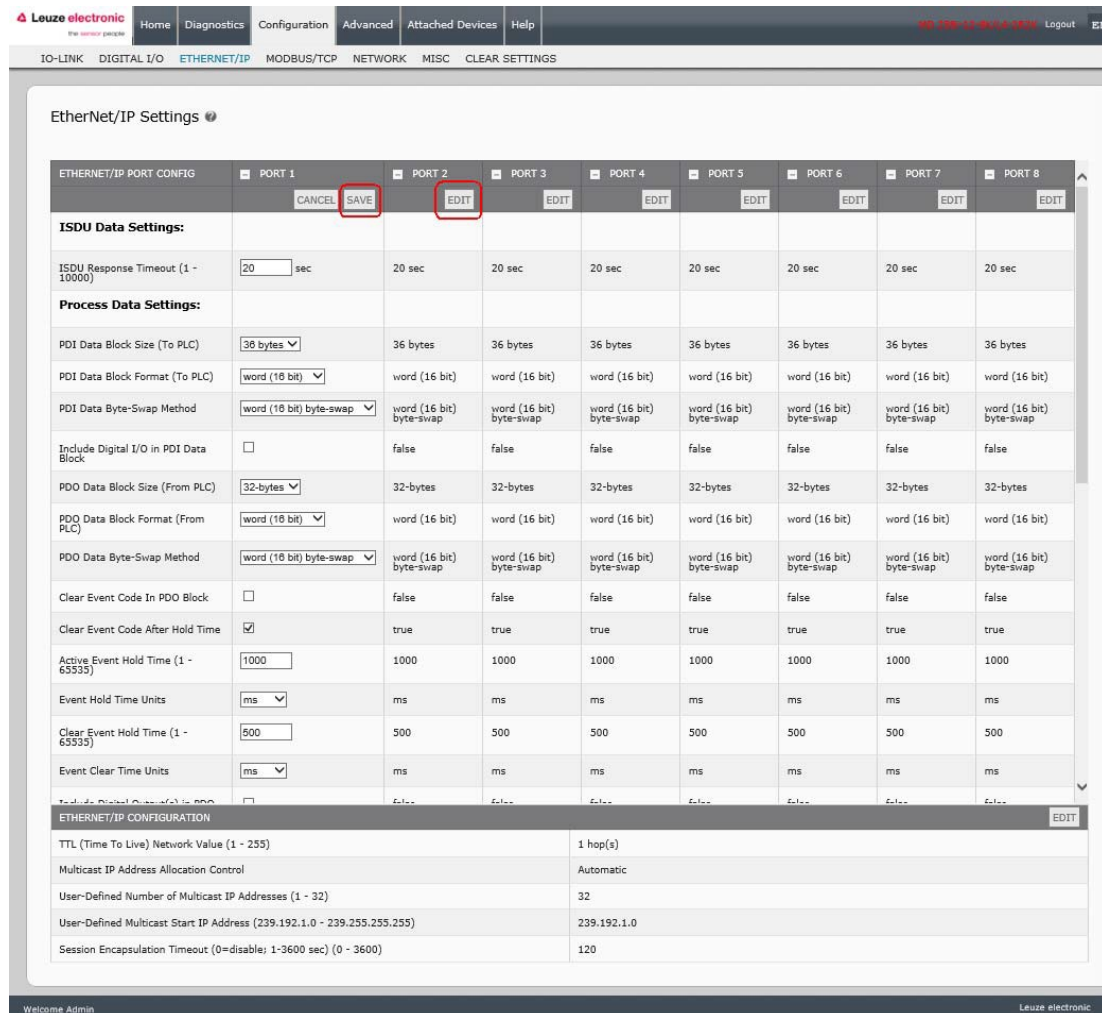

Figure 15: Editing EtherNet/IP Settings

6.3.2 EtherNet/IP Settings Parameters

The **Configuration | EtherNet/IP Settings** page supports the following options.

EtherNet/IP Settings Page	
<i>ISDU Data Settings</i>	
ISDU Response Timeout <i>Default: 20 seconds</i>	The time that the IO-Link Master’s EtherNet/IP interface waits for a response to an ISDU request. The timeout needs to set long enough to allow all commands within the ISDU request to be processed. Valid range: 1-10,000 seconds
<i>Process Data Settings</i>	
PDI Data Block Size (To PLC) <i>Default: 36-bytes</i>	The configurable PDI data block length. Supported optional lengths are: <ul style="list-style-type: none"> • 4-bytes (header only) • 8-bytes (4 bytes data) • 16-bytes (12 bytes data) • 24-bytes (20 bytes data) • 36-bytes (32 bytes data)
PDI Data Block Format (To PLC) <i>Default: Word-16</i>	Data format of PDI data block to be transferred to the PLC(s) in Class 1 and/or Write-to-Tag/File PDI Transfer Modes. Supported formats are: <ul style="list-style-type: none"> • Byte-8 (8-bit or SINT) • Word-16 (16-bit or INT) • Dword-32 (32-bit or DINT) <p><i>Note: The Data Block Format is independent of the PDI Data Byte-Swap Method.</i></p> <p><i>This setting is not used for the SLC, PLC-5 and MicroLogix PLCs which are always Word-16.</i></p>
PDI Data Byte-Swap Method <i>Default: Work (16-bit) byte swap</i>	If enabled, the IO-Link Master swaps the data bytes in word (2 byte) format or dword (4 byte) format. Supported values are: <ul style="list-style-type: none"> • No byte-swap – data passed through as received • Word (16-bit) byte-swap – data is byte-swapped in word format • Dword (32-bit) byte-swap – data is byte-swapped in dword format <p><i>Note: The byte swapping must be set correctly in order to convert from IO-Link (big-endian byte order), to EtherNet/IP (little-endian byte order).</i></p>
Include Digital I/O in PDI Data Block <i>Default: False</i>	If enabled, the IO-Link Master includes the current digital I/O pins D1 to D4 status in the PDI data block header. <ul style="list-style-type: none"> • False – Do not include the digital I/O pins status • True (enable check box) – Include the digital I/O pins status in PDI data block header <p><i>Note: Does not affect the Auxiliary Input.</i></p>

EtherNet/IP Settings Page	
<p>PDO Data Block Size (From PLC) <i>Default: 32-bytes</i></p>	<p>The configurable PDO data block length. Supported optional lengths are:</p> <ul style="list-style-type: none"> • Event code not included: <ul style="list-style-type: none"> • 4-bytes = all data • 8-bytes = all data • 16-bytes = all data • 24-bytes = all data • 32-bytes = all data • 34-bytes = 32 bytes data, 2 pad bytes • 36-bytes = 32 bytes data, 4 pad bytes • Event code included - PDO Data Format = Byte8: <ul style="list-style-type: none"> • 4-bytes = 2 byte event code, 2 data bytes • 8-bytes = 2 byte event code, 6 data bytes • 16-bytes = 2 byte event code, 14 data bytes • 24-bytes = 2 byte event code, 22 data bytes • 32-bytes = 2 byte event code, 30 data bytes • 34-bytes = 2 byte event code, 32 data bytes • 36-bytes = 2 byte event code, 32 data bytes, 2 byte pad • Event code included - PDO Data Format = word (16-bit): <ul style="list-style-type: none"> • 4-bytes = event code word, data word • 8-bytes = event code word, 3 data words • 16-bytes = event code word, 7 data words • 24-bytes = event code word, 11 data words • 32-bytes = event code word, 15 data words • 34-bytes = event code word, 16 data words • 36-bytes = event code word, 16 data words, pad word • Event code included - PDO Data Format = dword (32-bit): <ul style="list-style-type: none"> • 4-bytes = event code dword • 8-bytes = event code dword, data dword • 16-bytes = event code dword, 3 data dwords • 24-bytes = dword event code, 5 data dwords • 32-bytes = dword event code, 7 data dwords • 34-bytes = dword event code, 7 data dwords, 2 data bytes • 36-bytes = dword event code, 8 data dwords
<p>PDO Data Block Format (From PLC) <i>Default: Word-16</i></p>	<p>Data format of PDO data block received from the PLC(s) in Class 1 or Read from TagOrFile PDO Transfer Modes. Formats include:</p> <ul style="list-style-type: none"> • Byte-8 (8-bit) • Word-16 (16-bit) • Dword-32 (32-bit) <p><i>Note: The Data Block Format is independent of the PDO Data Byte-Swap Method.</i></p> <p><i>This setting is not used for the SLC, PLC-5 and MicroLogix PLCs which are always Word-16.</i></p>

EtherNet/IP Settings Page	
PDO Data Byte-Swap Method <i>Default:</i> Word (16-bit) byte-swap	If enabled, the IO-Link Master swaps the data bytes in word (2 byte) format or dword (4 byte) format. Supported values are: <ul style="list-style-type: none"> • No byte-swap – data passed through as received • Word (16-bit) byte-swap – data is byte-swapped in word format • Dword (32-bit) byte-swap – data is byte-swapped in dword format <i>Note: The byte swapping must be set correctly in order to convert from EtherNet/IP (little-endian byte order), to IO-Link (big-endian byte order).</i>
Clear Event Code in PDO Block <i>Default:</i> False	If enabled, the IO-Link Master expects the first 2 bytes, word, or dword of the PDO block to be used for event code handling. Supported values are: <ul style="list-style-type: none"> • True (enable check box) = expect event code • False = no event code, expect only PDO data
Clear Event Code After Hold Time <i>Default:</i> True	If enabled, the IO-Link Master clears any event code reported in the PDI data block after the Event Active Hold Time . Supported values are: <ul style="list-style-type: none"> • True (enable check box) = clear event code after hold time • False = do not clear event code after hold time
Active Event Hold Time <i>Default:</i> 1000 ms	If Clear Event Code After Hold time is enabled, the time period an event code is reported in the PDI block before it is cleared. <ul style="list-style-type: none"> • Valid range: 1-65535 • Valid units: <ul style="list-style-type: none"> • ms (milliseconds) • sec (seconds) • min (minutes) • hours • days
Event Hold Time Units <i>Default:</i> ms	<ul style="list-style-type: none"> • Valid units: <ul style="list-style-type: none"> • ms (milliseconds) • sec (seconds) • min (minutes) • hours • days
Clear Event Hold Time <i>Default:</i> 500 ms	Once an event code has been cleared, the time an event code stays cleared in the PDI block before another event code can be reported. <ul style="list-style-type: none"> • Valid range: 1-65535 • Valid units: <ul style="list-style-type: none"> • ms (milliseconds) • sec (seconds) • min (minutes) • hours • days
Include Digital Output(s) in PDO Data Block <i>Default:</i> False	If enabled, the IO-Link Master expects the digital output settings to be included in the PDO data block. False – The digital pin setting(s) are not included in the PDO data block. True (enable check box) – The digital pin setting(s) are included in the PDO data block.

EtherNet/IP Settings Page	
<i>Transfer Mode Settings</i>	
PDI Receive Mode(s) <i>Default: Polling, Class1</i>	Determines which PDI Receive (To PLC) Modes are enabled. Supported modes are: <ul style="list-style-type: none"> • Polling • Class1 • Write-to-TagOrFile
PDO Transmit Mode <i>Default: Class 1</i>	Supported modes are: <ul style="list-style-type: none"> • Off • PLC-Writes • Class1 • Read-from-TagOrFile
<i>Read/Write Tag/File Settings</i>	
PLC IP Address (xxx.xxx.xxx.xxx) <i>Default: 0.0.0.0</i>	The PLC IP Address is required if either Write-to-TagOrFile or Read-from- TagOrFile mode are enabled. Format: xxx.xxx.xxx.xxx
PLC Controller Slot Number <i>Default: 0</i>	The PLC Controller Slot Number is required if either Write-to-TagOrFile or Read-from-TagOrFile mode are enabled. Valid range: 0-64
PLC Type <i>Default: ControlLogix</i>	Indicates the type of PLC that the tag(s) or file(s) are written to and/or read from. Supported PLC Types are: <ul style="list-style-type: none"> • ControlLogix • SLC • PLC-5 • MicroLogix
<i>Write PDI to Tag/File Settings</i>	
PDI Tag/File Name <i>Default: blank</i>	The tag or file name to place the PDI data block. <ul style="list-style-type: none"> • ControlLogix family: <ul style="list-style-type: none"> • Tags must be same type as PDI Data Format (SINT, INT or DINT). • Tags must be an array. • Tags must be at least as long as the PDI Data Block Length. • SLC/PLC-5/MicroLogix: <ul style="list-style-type: none"> • Files must be of INTEGER (16-bit) type. • Files must be named with standard file name conventions (i.e: N10:0, N21:30, etc) • The file must be at least as long as the PDI Data Block Length.
Append PDO to PDI Data <i>Default: False</i>	If selected, the IO-Link Master appends any PDO data to the end of the PDI data. <ul style="list-style-type: none"> • False = Do not append PDO data • True (enable check box) = Append PDO data
Maximum PLC Update Rate <i>Default: 40ms</i>	The maximum rate at which the IO-Link Master updates the PDI tag or file. This parameter is used to ensure that the PLC receives all state changes. Setting the update rate to 10 ms effectively disables this feature. The valid range is 10 to 65535 ms.

EtherNet/IP Settings Page	
Heartbeat Update Enable <i>Default: False</i>	If selected, the IO-Link Master updates the PDI data block at the Heartbeat Update Rate . <ul style="list-style-type: none"> • False = Heartbeat update disabled • True (enable check box) = Heartbeat update enabled
Heartbeat Update Rate <i>Default: 1000ms</i>	If Heartbeat Update Enable is selected, the rate at which the IO-Link Master updates the PDI data block in the Write-to-Tag/File mode. The valid range is 50 to 65535 ms.
<i>Read PDO from Tag/File Settings</i>	
PDO Tag/File Name <i>Default: blank</i>	The tag or file name that the IO-Link Master reads the PDO data block from. <ul style="list-style-type: none"> • ControlLogix family: <ul style="list-style-type: none"> • Tags must be same type as PDO Data Format (SINT, INT or DINT). • Tags must be an array. • Tags must be at least as long as the PDO Data Block Length. • SLC/PLC-5/MicroLogix: <ul style="list-style-type: none"> • Files must be of INTEGER (16-bit) type. • Files must be named with standard file name conventions (i.e: N10:0, N21:30, etc) The file must be at least as long as the PDO Data Block Length .
PLC Poll Rate <i>Default: 1000ms</i>	The frequency which the IO-Link Master reads the PDO data block in the Read-from-Tag/File mode. Valid range: 50-65535 ms
TTL (Time To Live) Network Value (1-255) (<i>Default: 1</i>)	The TTL value indicates how many network “hops” can be made for Multicast packets. It is used to prevent Multicast packets from being forwarded beyond its own subnet(s). Each network router decreases the hop count when forwarding the Multicast packet. Once the hop count reaches zero, the Multicast packet is no longer forwarded.
Multicast IP Address Allocation Control (<i>Default: Automatic</i>)	This setting indicates how the starting Multicast address is determined. <ul style="list-style-type: none"> • Automatic – The IO-Link Master determines the starting Multicast IP address based on an EtherNet/IP specification algorithm. • User-Defined – The user sets the starting Multicast address.
User-Defined Number of Multicast IP Addresses (1-32) (<i>Default: 32</i>)	When the Multicast IP Address Allocation Control is set to User-Defined, the maximum number of Multicast addresses that the IO-Link Master may use.
User-Defined Multicast Start IP Address (239.192.1.0-239.255.255.255) (<i>Default: 239.192.1.0</i>)	When the multicast IP Address Allocation Control is set to User-Defined, the Multicast starting IP address for the IO-Link Master. Make sure you avoid redundant Multicast IP addresses on a network.
Session Encapsulation Timeout (0=disable; 1-3600 sec) (0 - 3600) (Default = 120)	Defines the inactivity period before an established session between a controller, such as a PLC, and the IO-Link Master will time out. If such a timeout occurs, the current session is closed and a new session must be established before communications can resume between the controller and the IO-Link Master.

6.4 Modbus/TCP Settings Configuration Page

You can use the Configuration | Modbus/TCP Settings page to configure Modbus/TCP with the IO-Link Master. This Chapter includes these topics:

- *Editing Modbus/TCP Settings, see Chapter 6.4.1*
- *Modbus/TCP Settings Parameters, see Chapter 6.4.2*

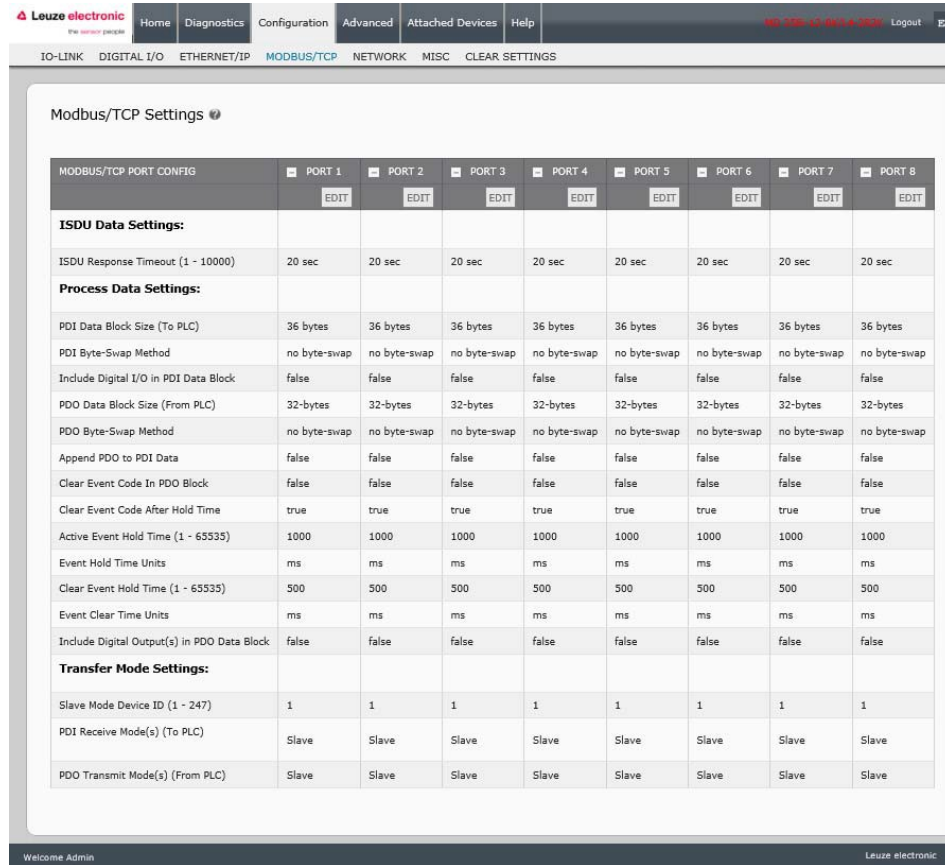

Figure 16: Modbus/TCP Settings Configuration Page

6.4.1 Editing Modbus/TCP Settings

1. If necessary, open the IO-Link Master web interface with your web browser using the IP address.
2. Click **Configuration | Modbus/TCP**.

Note: Click the **EDIT** button for the port that you want to configure.

*You can click each **EDIT** button and open all ports to quickly configure port parameters.*

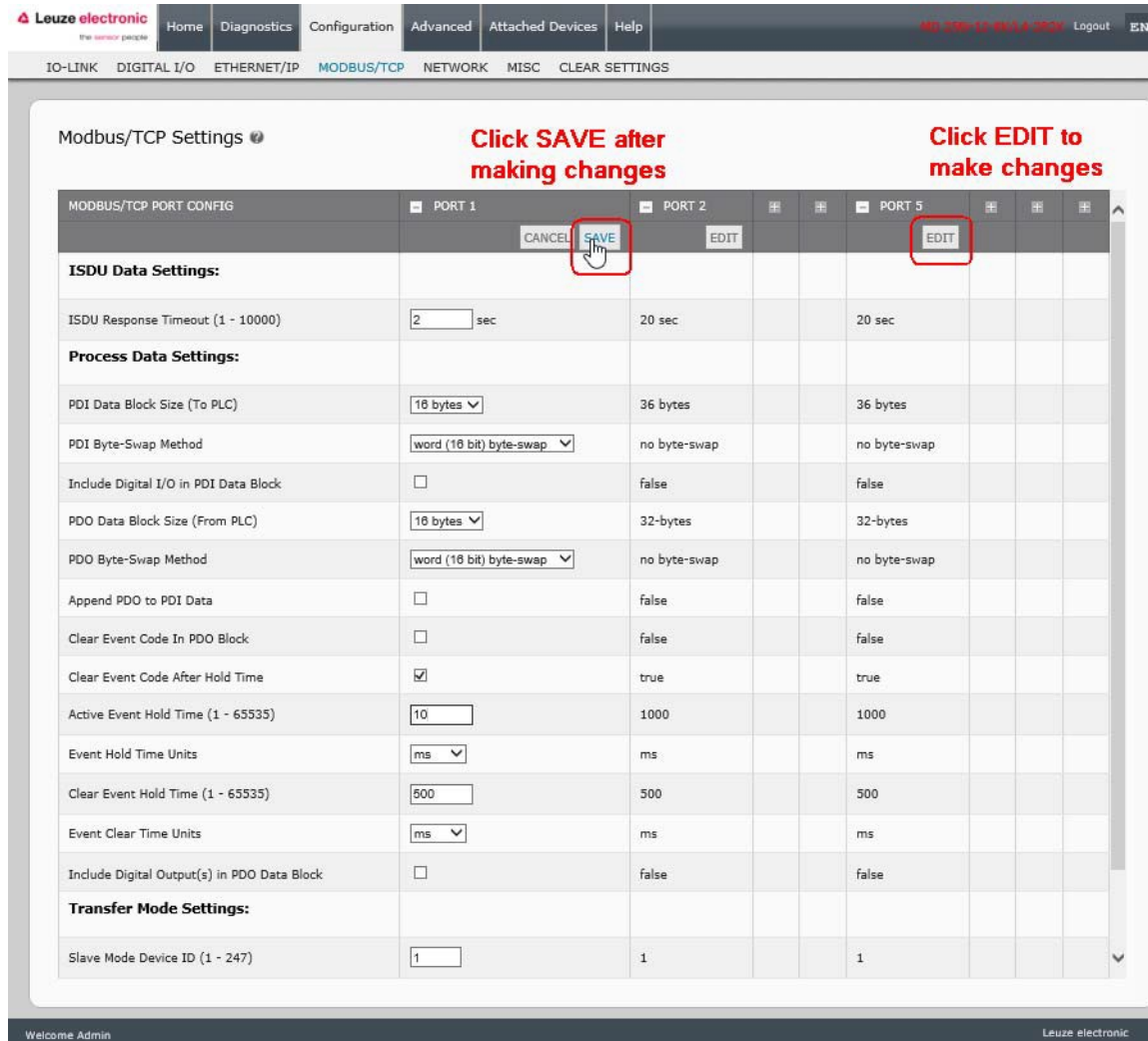

Figure 17: Editing Modbus/TCP Settings

3. Make appropriate selections for the IO-Link device that you will connect to that port. You can use the help system if you require definitions or values for the options or Chapter 6.4.2 Modbus/TCP Settings Parameters.
4. Scroll to the top of the page and click the **SAVE** button.
Make sure that the port now displays the **EDIT** button.
If it displays the **SAVE** and **CANCEL** buttons, that means that one of the parameters contains an incorrect value. If necessary, scroll down the page, make the needed corrections, and click **SAVE**.

6.4.2 Modbus/TCP Settings Parameters

The following table provides detailed information about the **Modbus/TCP Settings** page.

Modbus/TCP Settings Page	
ISDU Response Timeout <i>Default = 20 seconds</i>	The time that the IO-Link Master's Modbus/TCP interface waits for a response to an ISDU request. The timeout needs to set long enough to allow all commands within the ISDU request to be processed. Valid range: 1-10,000 seconds
<i>Process Data Settings</i>	
PDI Data Block Size <i>Default: 36-bytes</i>	The configurable PDI data block length. Optional lengths are: <ul style="list-style-type: none"> • 4-bytes (header only) • 8-bytes (4 bytes data) • 16-bytes (12 bytes data) • 24-bytes (20 bytes data) • 36-bytes (32 bytes data)
PDI Byte-Swap Method <i>Default: No byte-swap</i>	If enabled, the IO-Link Master swaps the data bytes in word (2 byte) format or dword (4 byte) format. Options include: <ul style="list-style-type: none"> • No byte-swap – data passed through as received • Word (16-bit) byte-swap – data is byte-swapped in word format • Dword (32-bit) byte-swap – data is byte-swapped in dword format <p><i>Note: Because both IO-Link and Modbus/TCP use big-endian byte ordering, byte swapping typically is not required for word and dword data.</i></p> <p><i>Byte swapping is most commonly required when receiving byte (8-bit) data and it is desired to place the first data byte in the least significant byte position of the holding register. For these cases, word (16 bit) byte-swap is typically used.</i></p>
Include Digital I/O in PDI Data Block <i>Default: False</i>	If enabled, the IO-Link Master includes the current digital I/O pins D1 to D4 status in the PDI data block header. <ul style="list-style-type: none"> • False – Do not include the digital I/O pins status • True (enable check box) – Include the digital I/O pins status in PDI data block header <p><i>Note: Does not affect the Auxiliary Input.</i></p>
PDO Data Block Size (From PLC) <i>Default: 32-bytes</i>	The configurable PDO data block length. Optional lengths are: Event code not included: <ul style="list-style-type: none"> • 4-bytes = 2 data words • 8-bytes = 4 data words • 16-bytes = 8 data words • 24-bytes = 12 data words • 32-bytes = 16 data words • 34-bytes = 16 data words, 1 pad word Event code included: <ul style="list-style-type: none"> • 4-bytes = event code word, 1 data word • 8-bytes = event code word, 3 data words • 16-bytes = event code word, 7 data words • 24-bytes = event code word, 11 data words • 32-bytes = event code word, 15 data words • 34-bytes = event code word, 16 data words

Modbus/TCP Settings Page	
PDO Byte-Swap Method <i>Default: No byte-swap</i>	If enabled, the IO-Link Master swaps the data bytes in word (2 byte) format or dword (4 byte) format. Options include: <ul style="list-style-type: none"> • No byte-swap – data passed through as received • Word (16-bit) byte-swap – data is byte-swapped in word format • Dword (32-bit) byte-swap – data is byte-swapped in dword format <p><i>Note: Because both IO-Link and Modbus/TCP use big-endian byte ordering, byte swapping typically is not required for word and dword data.</i></p> <p><i>Byte swapping is most commonly required when sending byte (8-bit) data to the IO-Link device and it is desired to send the least significant byte of the holding register first. For these cases, word (16 bit) byte-swap is typically used.</i></p>
Append PDO to PDI Data <i>Default: False</i>	If selected, the IO-Link Master appends any PDO data to the end of the PDI data. <ul style="list-style-type: none"> • False = Do not append PDO data • True (enable check box) = Append PDO data
Clear Event Code in PDO Block <i>Default: False</i>	If enabled, the IO-Link Master expects the first word of the PDO block to be used for event code handling. Values are: <ul style="list-style-type: none"> • True (enable check box) = expect event code • False = no event code, expect only PDO data
Clear Event Code After Hold Time <i>Default: True</i>	If enabled, the IO-Link Master clears any event code reported in the PDI data block after the Event Active Hold Time. Values are: <ul style="list-style-type: none"> • True (enable check box) = clear event code after hold time • False = do not clear event code after hold time
Active Event Hold Time <i>Default: 1000 ms</i>	If Clear Event Code After Hold Time is enabled, the time period an event code is reported in the PDI block before it is cleared. Valid range: 1-65535 Valid Units are: <ul style="list-style-type: none"> • ms (milliseconds) • sec (seconds) • min (minutes) • hours • days
Event Hold Time Units	Valid Units: <ul style="list-style-type: none"> • ms (milliseconds) • sec (seconds) • min (minutes) • hours • days

Modbus/TCP Settings Page	
Clear Event Hold Time <i>Default: 500 ms</i>	Once an event code has been cleared, the time an event code stays cleared in the PDI block before another event code can be reported. Valid range: 1-65535 Valid Units: <ul style="list-style-type: none"> • ms (milliseconds) • sec (seconds) • min (minutes) • hours • days
Event Clear Time Units	Valid Units: <ul style="list-style-type: none"> • ms (milliseconds) • sec (seconds) • min (minutes) • hours • days
Include Digital Output(s) in PDO Data Block <i>Default: False</i>	If enabled, the IO-Link Master expects the digital output settings to be included in the PDO data block. <ul style="list-style-type: none"> • False – The digital pin setting(s) are not included in the PDO data block • True (enable check box) – The digital pin setting(s) are included in the PDO data block
<i>Transfer Mode Settings</i>	
Slave Mode Device ID <i>Default: 1</i>	The Modbus Device ID used to access this IO-Link port. Range: 1-247
PDI Receive Mode(s) <i>Default: Slave</i>	Determines which PDI Receive (To PLC) Modes are enabled. The selectable modes is Slave. Note: <i>Not selecting slave mode disables Modbus/TCP access to the PDI data block.</i>
PDO Transmit Mode <i>Default: Slave</i>	Selectable Modes are: <ul style="list-style-type: none"> • Disabled • Slave

7 Dedicated Digital I/O Port Configuration

This chapter discusses the dedicated digital IO port (D1 through D4) configuration, including these topics:

- *Digital I/O Settings Page, see Chapter 7.1*
- *Editing Digital I/O Settings, see Chapter 7.2*
- *Digital I/O Setting Parameters, see Chapter 7.3*

7.1 Digital I/O Settings Page

Use the **Configuration | Digital I/O** page to configure the dedicated DIO port characteristics for the IO-Link Master. **D1** and **D2** are located next to IO-Link Port 1 and **D3** and **D4** are located next to IO-Link Port 4.

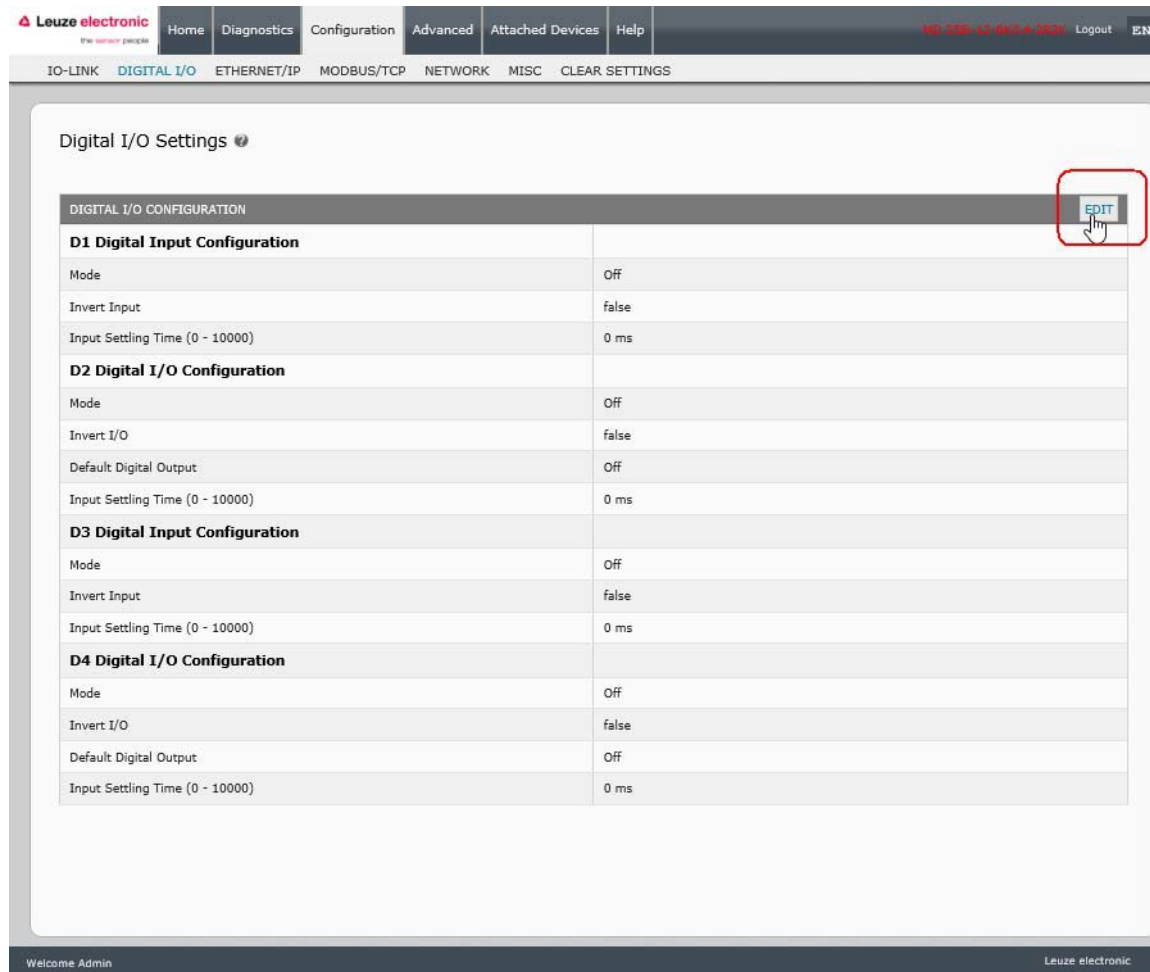

Figure 18: Digital I/O settings

7.2 Editing Digital I/O Settings

You can use this procedure to configure digital I/O characteristics for the digital I/O ports.

1. If necessary, open the IO-Link Master web interface with your web browser using the IP address.
2. Click **Configuration | Digital I/O**.
3. Click the **EDIT** button.
4. Make appropriate selections for the digital I/O device or devices that you will connect to the ports. You can use the help system if you require definitions or values for the options or *Digital I/O Setting Parameters*.

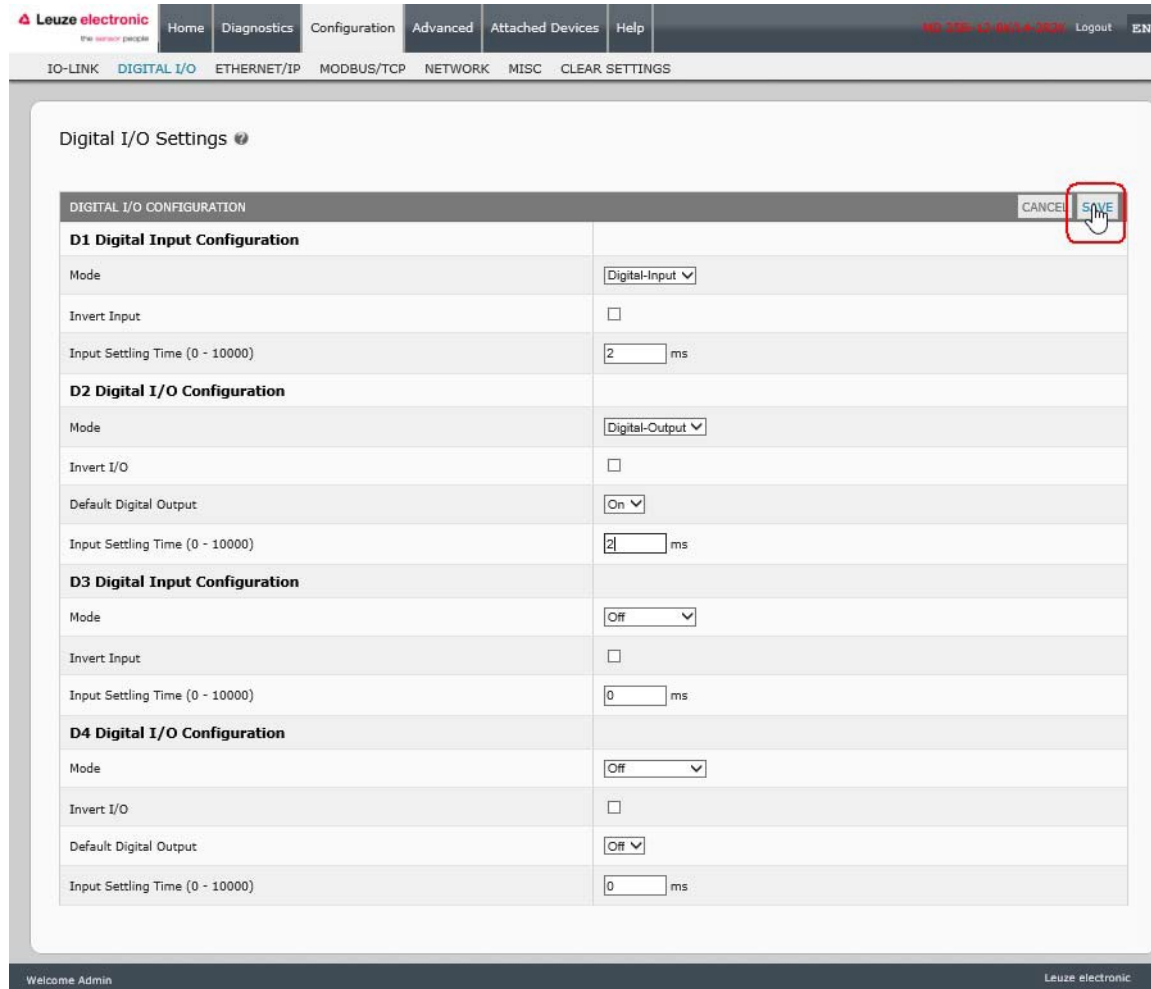

Figure 19: Save Digital I/O settings

5. Click the **SAVE** button.

7.3 Digital I/O Setting Parameters

Digital I/O Settings Page	
D1 Digital Input Configuration	
Mode Default = Off	Selects the Mode : <ul style="list-style-type: none"> • Off – No monitoring of the digital input pin. • Digital-Input – monitors the digital input status
Invert Input Default= False	If Mode is set to Digital-Input , the input status is inverted.
Input Settling Time (0 - 10000ms) Default= 0ms	If non-zero and Mode is set to Digital-Input , the required time that the input status must remain constant before an input status change is reported.
D2 Digital I/O Configuration	
Mode <i>Default= Off</i>	Selects the Mode : <ul style="list-style-type: none"> • Off – No monitoring or setting of the digital I/O pin. • Digital-Input – monitors the digital input status • Digital-Output – sets the digital output to either the default setting or value received from a controller.
Invert I/O <i>Default= False</i>	If selected: <ul style="list-style-type: none"> • If Mode is set to Digital-Input, the input status is inverted. • If Mode is set to Digital-Output, the output setting is inverted.
Default Digital Output <i>Default= Off</i>	If Mode is set to Digital Output , defines the default digital output setting: <ul style="list-style-type: none"> • At startup before a controller can set the digital output. • When communication to all controller(s) has been lost. Possible settings: <ul style="list-style-type: none"> • Off - low voltage • On – high voltage
Input Settling Time (0 - 10000ms) <i>Default= 0ms</i>	If non-zero and Mode is set to Digital-Input , the required time that the input status must remain constant before an input status change is reported.
D3 Digital Input Configuration	
Mode <i>Default= Off</i>	Selects the Mode : <ul style="list-style-type: none"> • Off – No monitoring of the digital input pin. • Digital-Input – Monitors the digital input status
Invert Input <i>Default= False</i>	If Mode is set to Digital-Input , the input status is inverted.
Input Settling Time (0 - 10000) <i>Default= 0ms</i>	If non-zero and Mode is set to Digital-Input , the required time that the input status must remain constant before an input status change is reported.
D4 Digital I/O Configuration	
Mode <i>Default= Off</i>	Selects the Mode : <ul style="list-style-type: none"> • Off – No monitoring or setting of the digital I/O pin. • Digital-Input – Monitors the digital input status • Digital-Output – sets the digital output to either the default setting or value received from a controller.
Invert I/O <i>Default= False</i>	If selected: <ul style="list-style-type: none"> • If Mode is set to Digital-Input, the input status is inverted. • If Mode is set to Digital-Output, the output setting is inverted.

Digital I/O Settings Page	
<p>Default Digital Output <i>Default= Off</i></p>	<p>If Mode is set to Digital Output, defines the default digital output setting:</p> <ul style="list-style-type: none"> • At startup before a controller can set the digital output. • When communication to all controller(s) has been lost. <p>Possible settings:</p> <ul style="list-style-type: none"> • Off - low voltage • On – high voltage
<p>Input Settling Time (0 - 10000) <i>Default= 0ms</i></p>	<p>If non-zero and Mode is set to Digital-Input, the required time that the input status must remain constant before an input status change is reported.</p>

8 Loading and Managing IODD Files

There are several **Attached Devices** pages that support IO-Link Device Description (IODD) file management.

- *IO-Link Device Description Files Page* - load IODD files from the IO-Link device manufacturer onto the IO-Link Master, see Chapter 8.1.
- *IO-Link Device Configuration Summary Page* - verify the correct files were loaded for each IO-Link device, see Chapter 8.2.
- The Port pages are discussed in *Chapter 9 Configuring IO-Link Devices*.

8.1 IO-Link Device Description Files Page

Use the **IO-Link Device Description Files** page to update (upload) and delete IO-Link Device Description (IODD) files associated with this IO-Link Master. In addition, you can review the IODD **xml** file by clicking the **IODD FILENAME** in the table after loading the IODD file.

Note: You will need to download the appropriate IODD files from your IO-Link device manufacturer.

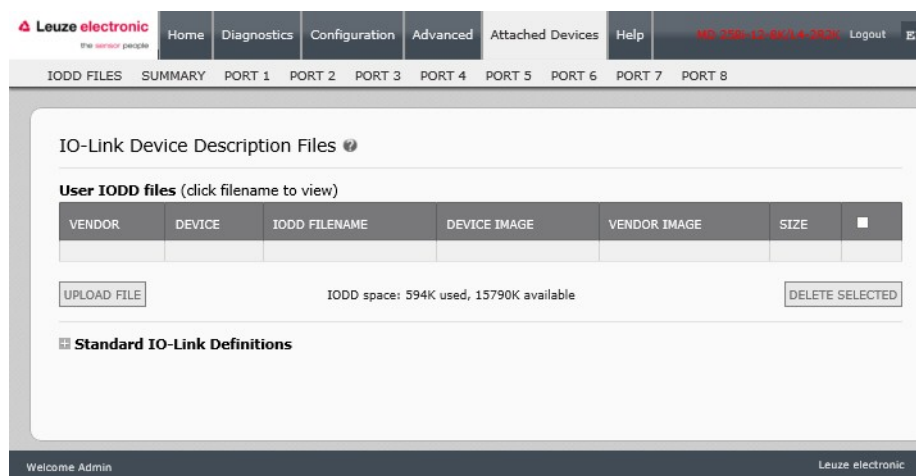

Figure 20: IO-Link Device Description files page

The IO-Link Master provides 15790K of space to store IODD files. The IO-Link Master includes the following default IODD files, which cannot be deleted.

- **IODD-StandardDefinitions1.0.1.xml**
- **IODD-StandardUnitDefinitions1.0.1.xml**
- **IODD-StandardDefinitions1.1.xml**
- **IODD-StandardUnitDefinitions1.1.xml**

8.1.1 Preparing IODD Files to Upload

After downloading the IODD files for the IO-Link device from the IO-Link sensor or actuator manufacturer, you may need to unzip the file and locate the appropriate **xml** file for the device.

- Some IODD zip files contain the **xml** files and supporting image files for a single product. This type of zip file can be immediately loaded onto the IO-Link Master.
- Some IODD zip files contain the files for multiple products. If you upload this type of IODD zip file, the IO-Link Master loads the first **xml** file and the associated image files, which may or may not correspond to the IO-Link device connected to the port. If you need to zip the appropriate files, the following information may be useful:
 - Unzip the package and locate the **xml** file needed for your IO-Link device.
 - Open the **xml** file and search for the **productID**, which identifies the IO-Link device.

- Zip the **xml** file along with the supporting images. There are several ways to locate the supporting images:
 - Locate the appropriate images using the **xml** file.
 - Load only the **xml** file and the IO-Link Master notifies you what files are missing. Use the **UPDATE** feature to upload the missing images.
 - Zip the **xml** with all of the images and the IO-Link Master ignores (and not upload) any unused files and notifies which files did not upload.

Note: Image files are not required for IO-Link device configuration.

Use the appropriate discussion for your IODD files.

- *Uploading IODD Zip Files, see Chapter 8.1.2*
- *Uploading xml Files or Supporting Files, see Chapter 8.1.3*

8.1.2 Uploading IODD Zip Files

You can use the following procedure to upload IODD zip files.

1. Click **Attached Devices** and **IODD FILES**.
2. Click the **UPLOAD FILE** button.
3. Click the **CHOOSE FILE** button and browse to the file location.
4. Highlight the **zip** file, click **Open** and then the **UPLOAD** button.

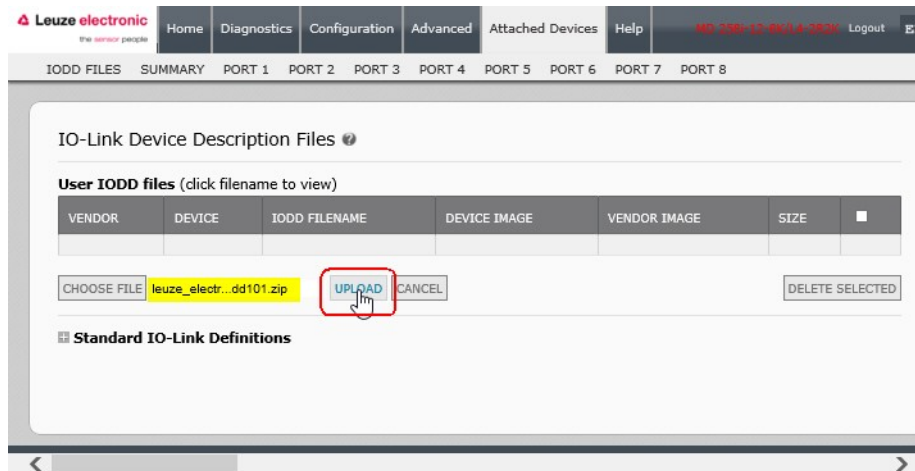

Figure 21: Upload IO-Lin Device Description file

5. If necessary, click **Ok**.

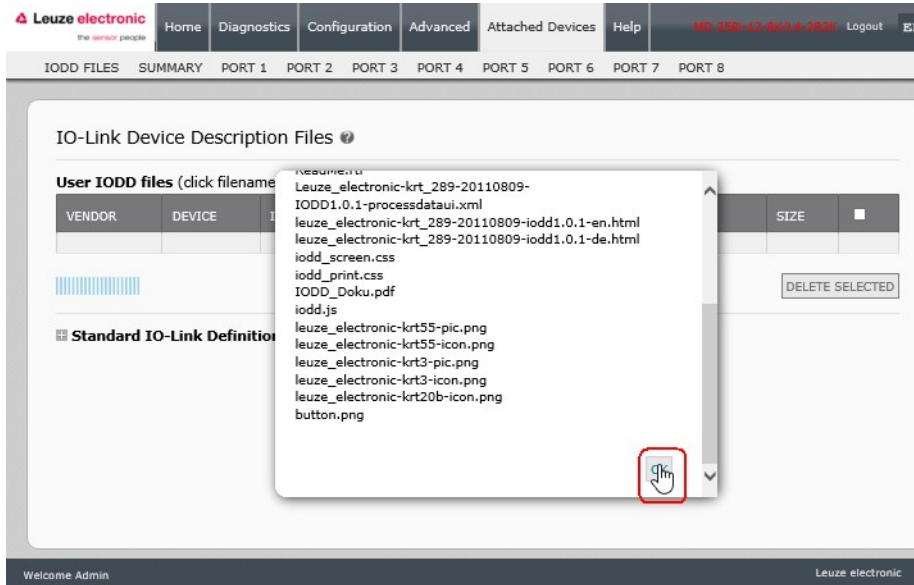

Figure 22: Confirm upload

Note: Only images referenced in the xml file load to the IO-Link Master and the remaining files are ignored.

6. If desired, you can view the **xml** file by clicking the **IODD FILENAME** in the table.

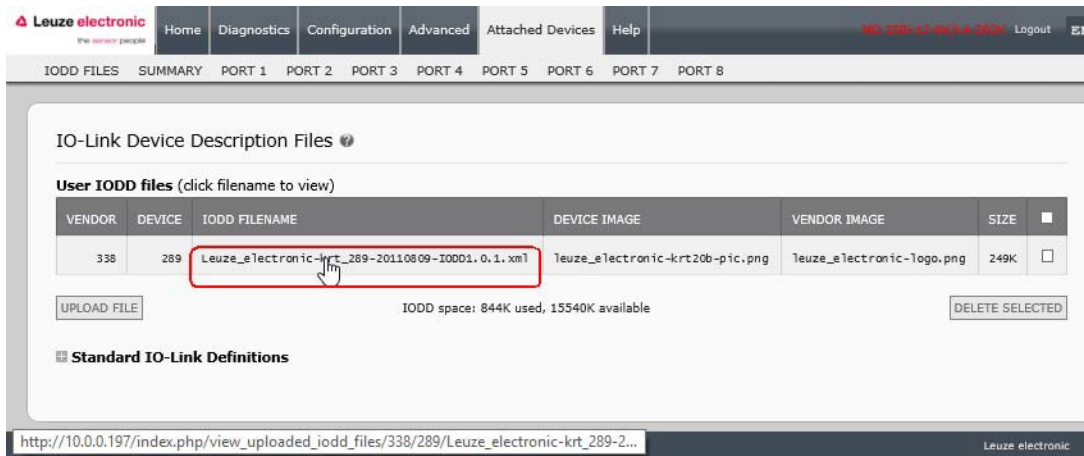

Figure 23: View IODD file

7. Click the hyperlink at the top of the page if you want to view the **xml** file in your browser.

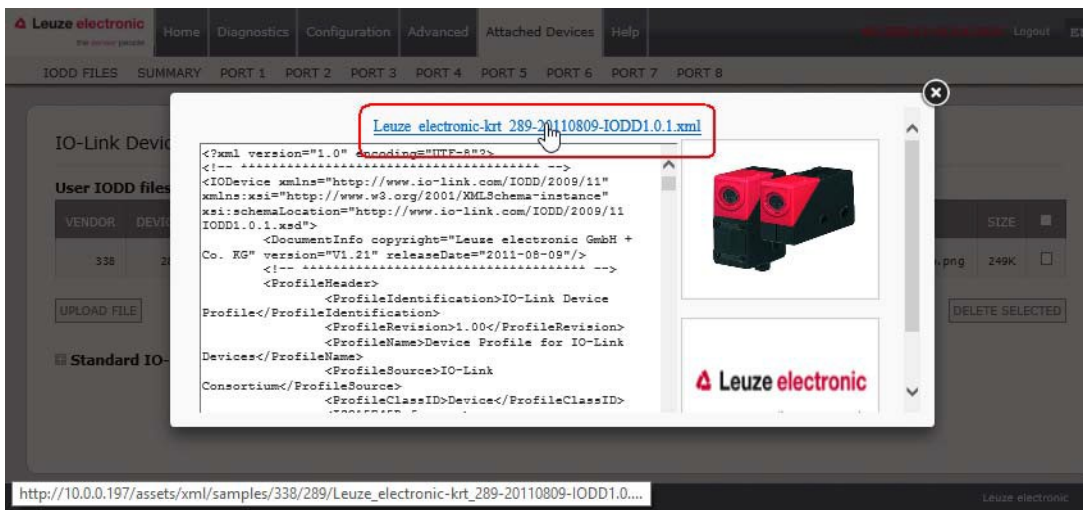

Figure 24: Open IODD file in your browser

8. Optionally, verify that the correct **xml** file was loaded using the **Summary** page (Page 63).

8.1.3 Uploading xml Files or Supporting Files

You can use the following procedure to upload **xml**, or supporting image files.

1. Click **Attached Devices** and **IODD FILES**.
2. Click the **UPLOAD FILE** button.
3. Click the **CHOOSE FILE** button and browse to the file location.
4. Highlight the **xml** or image file and click **Open**.

Note: The **xml** file must be loaded before the IO-Link Master will load the associated image files.

5. Click the **UPLOAD** button.

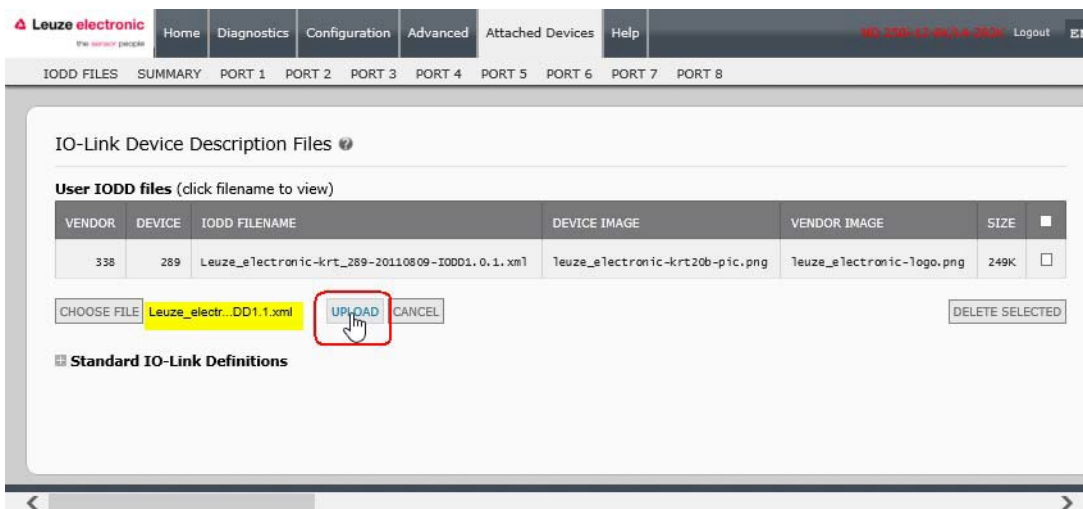

Figure 25: Upload IODD file

Note: The IO-Link Master notifies you what files are missing. The missing files do not affect the operation of the IODD Port page but the product image and logo for the IO-Link device company do not display.

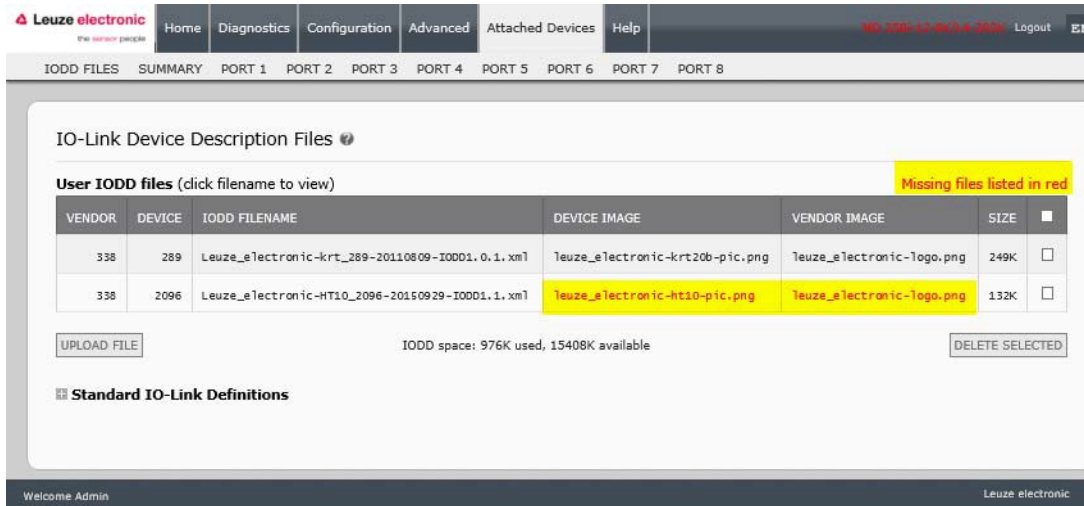

Figure 26: Notification of missing files

6. Optionally, use the following steps to load image files:
 - a. Select the row in the table that contains the **xml** file.
 - b. Click the **UPLOAD FILE** button and browse to the file location.

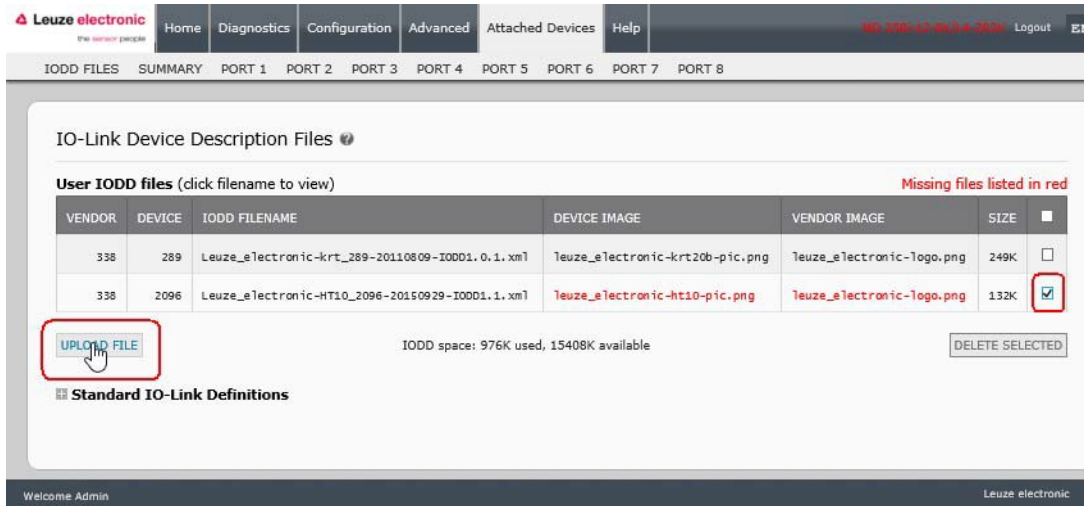

Figure 27: Upload file for highlighted device

- c. Click the **Choose File** button and browse to the file location.
- d. Highlight the file and click **Open**.
- e. Click the **UPLOAD** button.
- f. If desired, you can view the **xml** file by clicking the **IODD FILENAME** in the table.
- g. Optionally, verify that the correct **xml** file was loaded using the **Summary** page (Page 63).

8.1.4 Viewing and Saving IODD Files

Use the following procedure to view the contents of an IODD file.

1. If necessary, click **Attached Devices** and **IODD Files**.
2. Click the **IODD FILENAME** in the table that you want to review. A pop up window displays the contents of the IODD file.
3. Optionally, click the file name hyperlink at the top of the window to view the formatted file or if you want to save a copy of the file to another location.

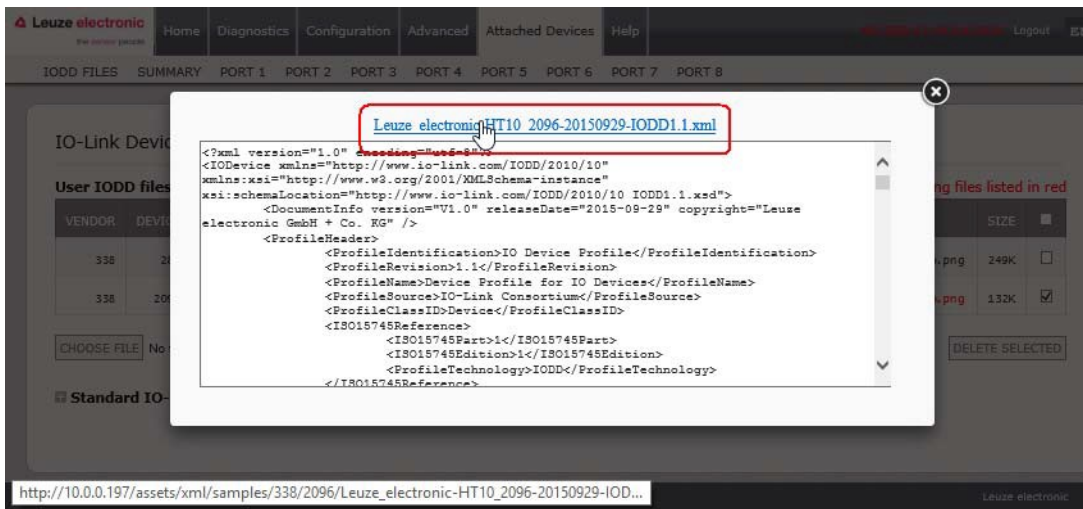

Figure 28: File name hyperlink

8.1.5 Deleting IODD Files

Use the following procedure to delete an IODD file set from the IO-Link Master.

1. If necessary, click **Attached Devices** and **IODD Files**.
2. Check the corresponding row of the IODD file that you want to delete.
3. Click the **DELETE SELECTED** button.

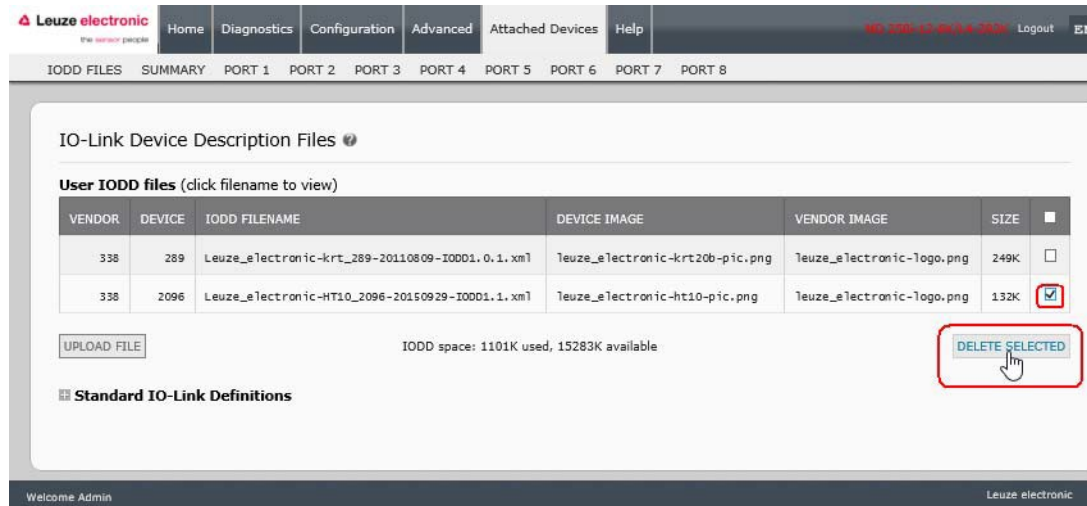

Figure 29: Deleting IODD files

4. Click **CONTINUE** to the *Delete files?* message.

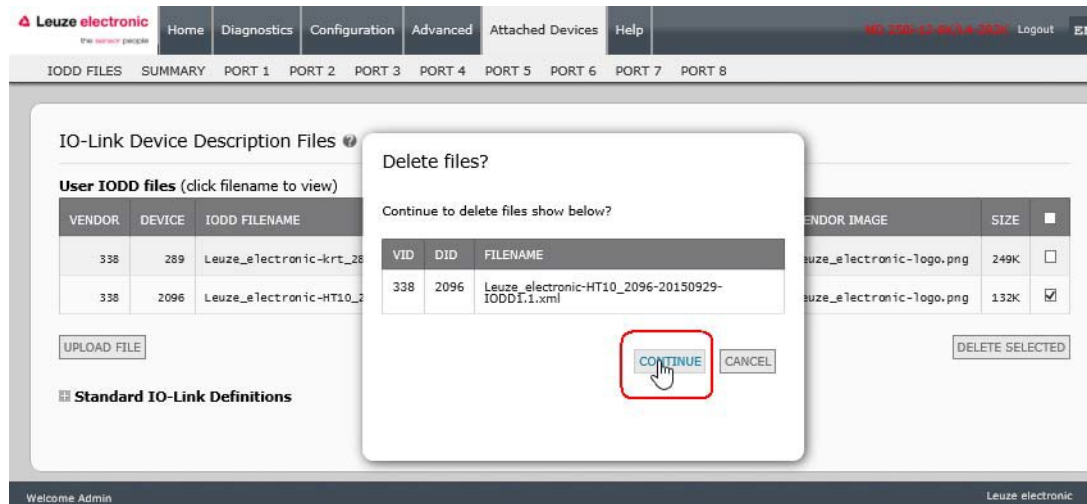

Figure 30: Confirm deleting of IODD files

8.2 IO-Link Device Configuration Summary Page

The **IO-Link Device Configuration Summary** page provides basic device configuration (device profile) information for ports with valid IO-Link devices attached. The **Configuration Summary** page retrieves information that resides on the IO-Link device from the manufacturer.

A file name displayed in the **IODD Name** field for a port indicates that a valid IODD file is associated with that device. If the field is empty, that indicates that a valid IODD file has not been loaded.

You can review complete IODD file information on a port by port basis by clicking the **MORE** button next to the port in question or by clicking the **PORT** menu selection in the navigational bar.

Use the following steps to access the **IO-Link Device Configuration Summary** page.

1. Click **Attached Devices**.
2. Click **SUMMARY**.

Note: The Configuration Summary page takes several minutes to completely load as each device is queried.

3. Click the **MORE** button or the corresponding **Port** (in the navigational bar) to configure the IO-Link device parameters for a specific device. See *Chapter 9 Configuring IO-Link Devices* for more information.

The screenshot shows the 'IO-Link Device Configuration Summary' page. At the top, there is a navigation bar with 'Attached Devices' selected. Below it, a sub-navigation bar shows 'SUMMARY' selected. A red message states: 'No IO-Link devices on Ports 3, 4, and 6 - 8'. The main content is a table with columns for 'DEVICE SETTINGS' and 'PORT1' through 'PORT8'. Each port column has a 'MORE' button. The table data is as follows:

DEVICE SETTINGS	PORT1	MORE	PORT2	MORE	PORT3	MORE	PORT4	MORE	PORT5	MORE	PORT6	MORE	PORT7	MORE	PORT8	MORE
Vendor Name	Leuze electronic GmbH + Co. KG		Leuze electronic GmbH + Co. KG						Leuze electronic GmbH + Co. KG							
VENDOR	338		338						338							
DEVICE	289		2096						384							
Description	contrast scanner		Scanner with Background Suppression						Diffuse Reflection Light Scanner With Background Suppression							
IO-Link Version	1.0		1.1						1.1							
Hardware Version	L		B000						C							
Firmware Version	02.20		1.1						01.15							
Baud Rate	38400		38400						38400							
SIO Mode	Yes		Yes						Yes							
Min Cycle Time	2.5 ms		2.3 ms						7.2 ms							
IODD Name	Leuze_electronic-kr_289-20110809-IODD1.0.1.xml		Leuze_electronic-HT10_2096-20150529-IODD1.1.xml						Leuze_electronic-htr46b_384-20120228-IODD1.0.1.xml							
Serial Number	1408L068197		01540018205						1111C000485							

Figure 31: IO-Link summary page

9 Configuring IO-Link Devices

This chapter discusses using the **Attached Devices | Port** pages to change IO-Link device parameters.

Note: Optionally, you can use traditional methods such as: PLC interfaces to configure the IO-Link devices.

9.1 Port Pages Overview

You can use the **Attached Devices | Port** page for a port to review and easily edit the IO-Link device configuration.

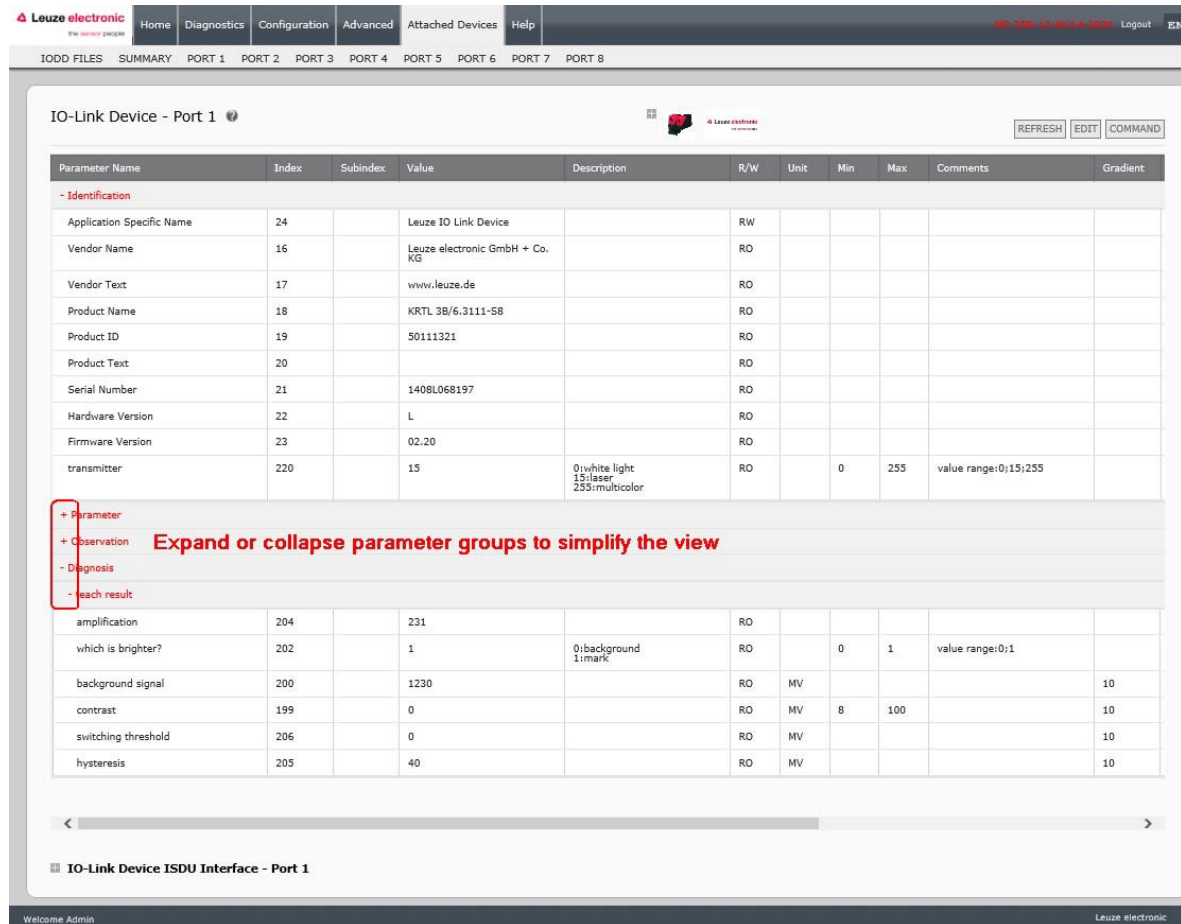

Figure 32: IO-Link port overview page

The **Port** page provides two IO-Link device configuration methods:

- **IO-Link Device Port** table (GUI), which depends on the appropriate IODD file loaded from the IO-Link device manufacturer onto the IO-Link Master. To use the **IO-Link Device Port** table for configuring IO-Link devices, refer to the following chapters:
 - *Editing Parameters - IO-Link Device - Port Table, see Chapter 9.2*
 - *Resetting IO-Link Device Parameters to Factory Defaults, see Chapter 9.3*
- **IO-Link Device ISDU Interface - Port**, which can be used with or without IODD files loaded. Refer to the following information to use the **IO-Link Device ISDU Interface - Port** method:
 - The *IO-Link Device Operator Manual* from the device manufacturer is needed to use the **IO-Link Device ISDU Interface** since ISDU block index and ISDU sub-index numbers are required.
 - *Editing Parameters - IO-Link Device ISDU Interface - Port, see Chapter 9.4*

9.2 Editing Parameters - IO-Link Device - Port Table

Use the following procedure to edit IO-Link device parameters using the IO-Link Device Port table.

Note: You may want to verify that the **Automatic Download Enable for Data Storage** option on the **Configuration | IO-Link Settings** page is **NOT** set to **On** as this can cause unreliable results on the corresponding port.

1. If you have not done so, load the IODD file from the IO-Link device manufacturer (*Chapter 8 Loading and Managing IODD Files*).
2. Access the appropriate **Port** page by clicking **Attached Devices** and then the **Port** number that you want to configure.
3. Click the **EDIT** button after all of the device information is populated in the table.
4. Scroll down the table and make appropriate parameter changes for your environment.

Note: An IODD file may not contain every IO-Link device setting depending on the IO-Link device manufacturer. If you need to change a parameter that is not displayed in the IO-Link Device - Port table, you can refer to the IO-Link device Operators Manual and use the IO-Link Device ISDU Interface to change the settings.

You may need to scroll to the right in the table to view applicable parameter values if the parameter is not selectable in a drop list.

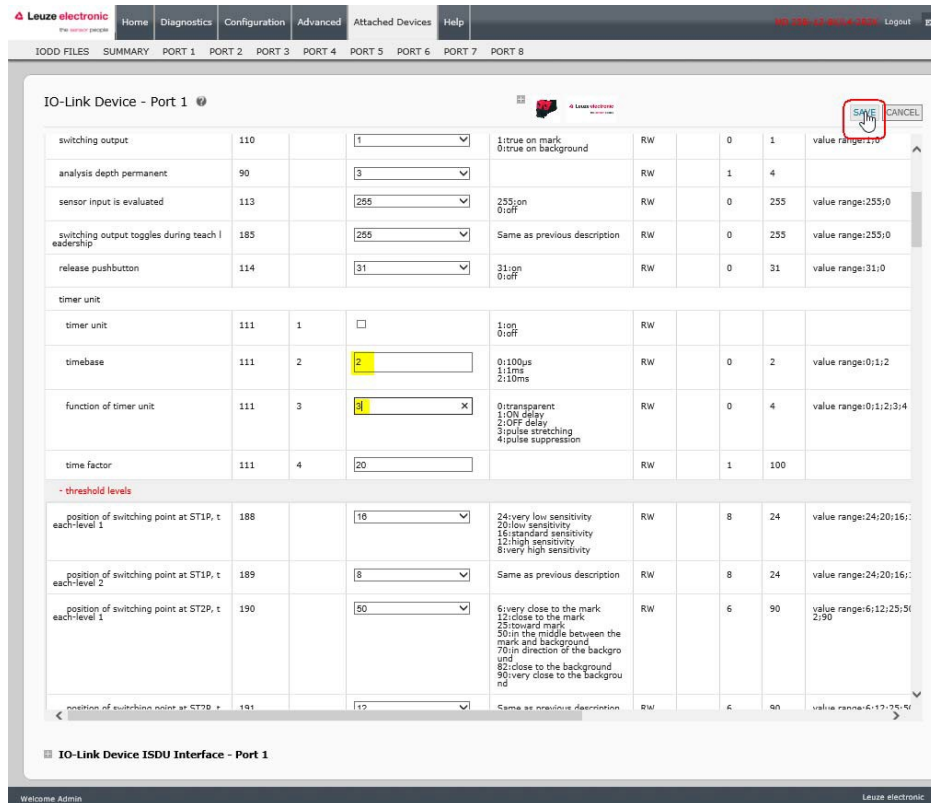

Figure 33: IO-Link device settings

5. Click the **SAVE** button after editing the parameters.

The screenshot shows the Leuze electronic web interface for configuring an IO-Link device on Port 1. The interface includes a navigation menu at the top with options like Home, Diagnostics, Configuration, Advanced, Attached Devices, and Help. Below the navigation, there are buttons for REFRESH, EDIT, and COMMAND. The main content area displays a table of parameters for the IO-Link device. The parameters are organized into sections: Serial Number, Hardware Version, Firmware Version, transmitter, - Parameter, timer unit, and - threshold levels. The 'timebase' parameter is highlighted in yellow, indicating it is the current focus of the configuration. The table columns include parameter ID, value, description, access type (RW), and value range.

Parameter	ID	Value	Description	Access	Min	Max	Value Range
Serial Number	21	1408L068197		RO			
Hardware Version	22	L		RO			
Firmware Version	23	02.20		RO			
transmitter	220	15	0:white light 15:laser 255:multicolor	RO	0	255	value range:0;15;255
- Parameter							
switching output	110	1	1:true on mark 0:true on background	RW	0	1	value range:1;0
analysis depth permanent	90	3		RW	1	4	
sensor input is evaluated	113	255	255:on 0:off	RW	0	255	value range:255;0
switching output toggles during teach leadership	185	255	Same as previous description	RW	0	255	value range:255;0
release pushbutton	114	31	31:on 0:off	RW	0	31	value range:31;0
timer unit							
timer unit	111	1	0	RW			
timebase	111	2	2	RW	0	2	value range:0;1;2
function of timer unit	111	3	3	RW	0	4	value range:0;1;2;3;4
time factor	111	4	20	RW	1	100	
- threshold levels							
position of switching point at ST1P, t each-level 1	188	16	24:very low sensitivity 20:low sensitivity 16:standard sensitivity 12:high sensitivity 8:very high sensitivity	RW	8	24	value range:24;20;16;12;8
position of switching point at ST1P, t each-level 2	189	8	Same as previous description	RW	8	24	value range:24;20;16;12;8

Figure 34: Save IO-Link device settings

9.3 Resetting IO-Link Device Parameters to Factory Defaults

In the event you want to reset the IO-Link device to factory default, typically the IODD file provides the ability from the IO-Link device manufacturer. Use the following example to reset an IO-Link device.

1. Click the **COMMAND** button and locate the **Restore Factory** button.
2. Click the **Restore Factory** or **Load Factory Settings** button.

Note: The name of the button is determined by the IO-Link device manufacturer.

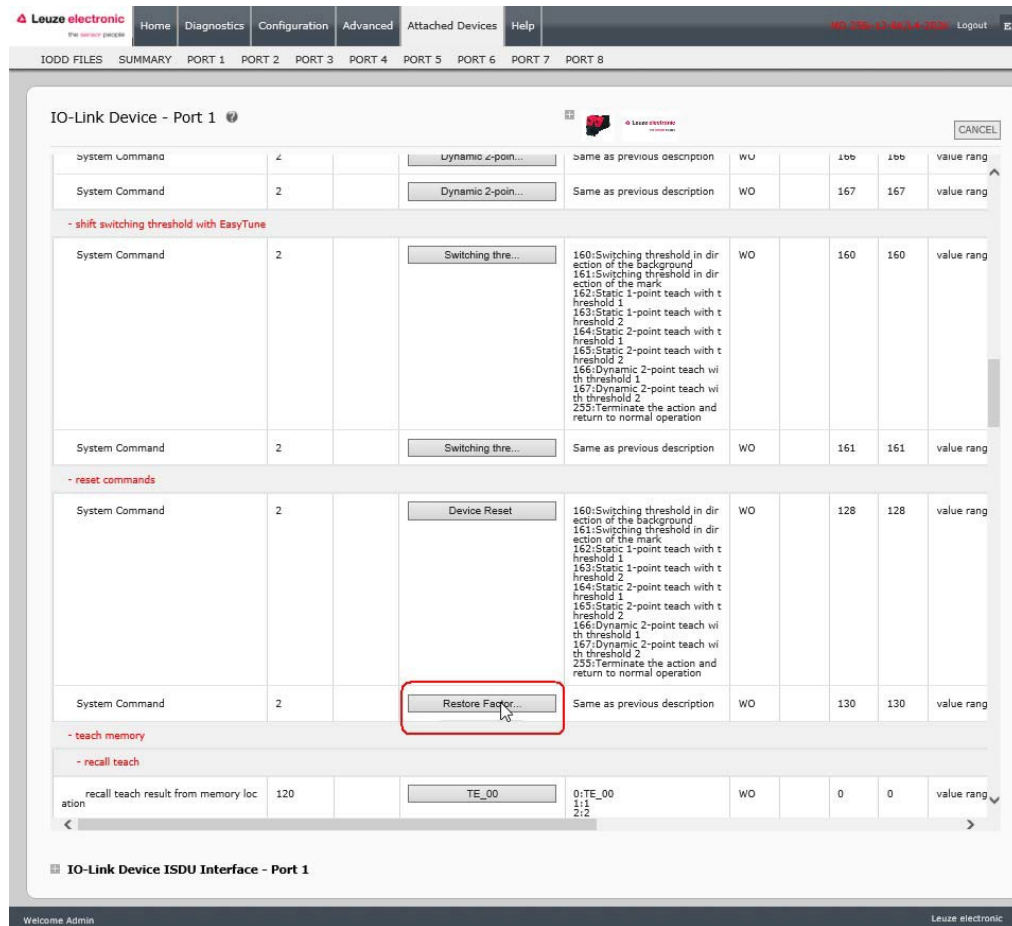

Figure 35: IO-Link device restore factory settings

3. Click OK when the *Refresh* message appears.

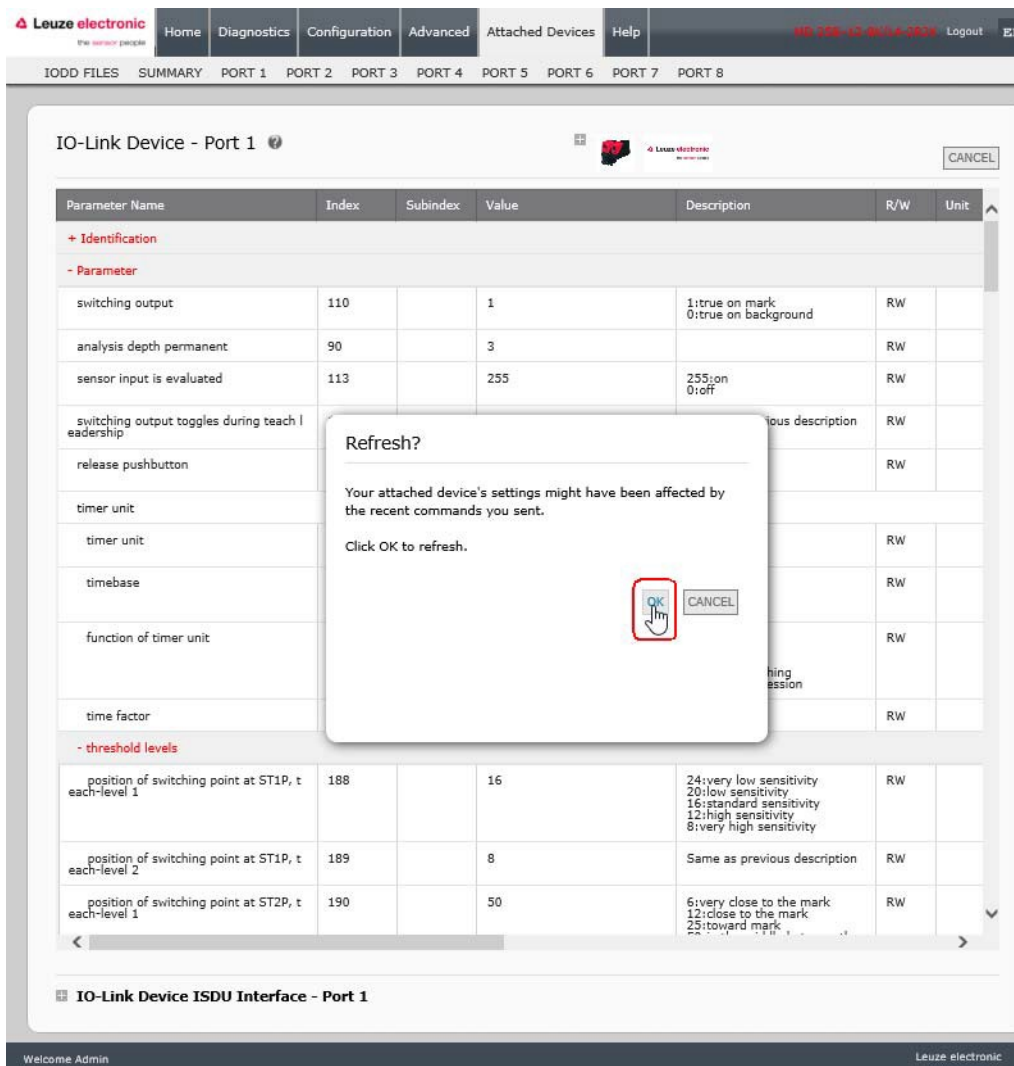

Figure 36: Confirm restore command

9.4 Editing Parameters - IO-Link Device ISDU Interface - Port

The IO-Link Device ISDU Interface follows these guidelines:

- If necessary, convert hexadecimal ISDU index numbers to decimal, you must enter the decimal value for the ISDU Block Index and ISDU Sub-index numbers.
- You must enter the hexadecimal value for the IO-Link device parameters.

If the appropriate IODD files has been loaded, you can use the IO-Link Device - Port table to determine the index numbers and acceptable values for each parameter.

Note: An IODD file may not contain every IO-Link device setting depending on the IO-Link device manufacturer. If you need to change a parameter that is not displayed in the IO-Link Device - Port table, you can refer to the IO-Link Device Operators Manual.

If an IODD file has not been loaded for an IO-Link device, you can use the IO-Link Device Operator's Manual to determine the ISDU indexes.

Please note:

- You must enter the decimal value for the ISDU Block Index and ISDU Sub-index.
- The GET button retrieves the parameter value in hex from the IO-Link device. You may want to retrieve values to determine the data length.



- The SET button sends the value to the IO-Link device.

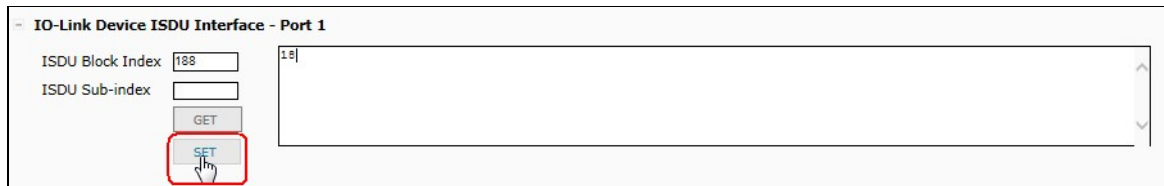

- After successfully changing a parameter, the IO-Link Master responds with a command executed notification.

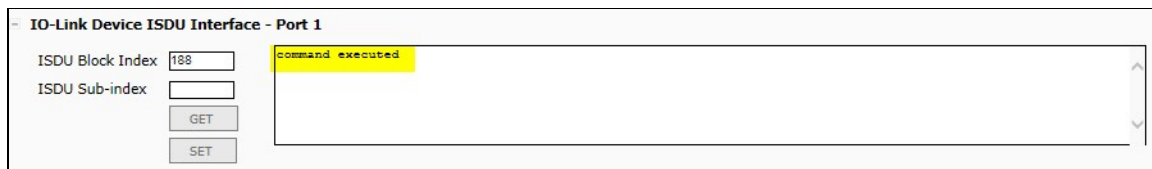

- This message means that the IO-Link device defines the entry as an invalid setting.

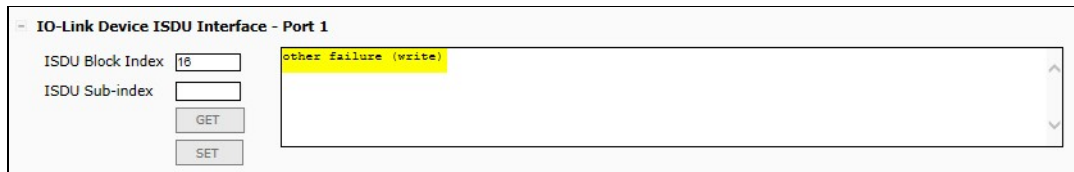

- This message indicates that the IO-Link device cannot read the specified ISDU Block Index and Sub- index.

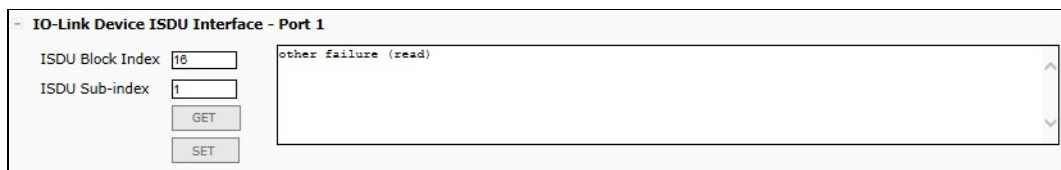

Use the following procedure to edit parameters using the **IO-Link Device ISDU Interface - Port**.

Note: You may want to verify that the **Automatic Download Enable for Data Storage** option on the **Configuration | IO-Link Settings** page is **NOT** set to **On** as this can cause unreliable results on the corresponding port.

1. Click the **+** next to the **IO-Link Device ISDU Interface** to open the interface.

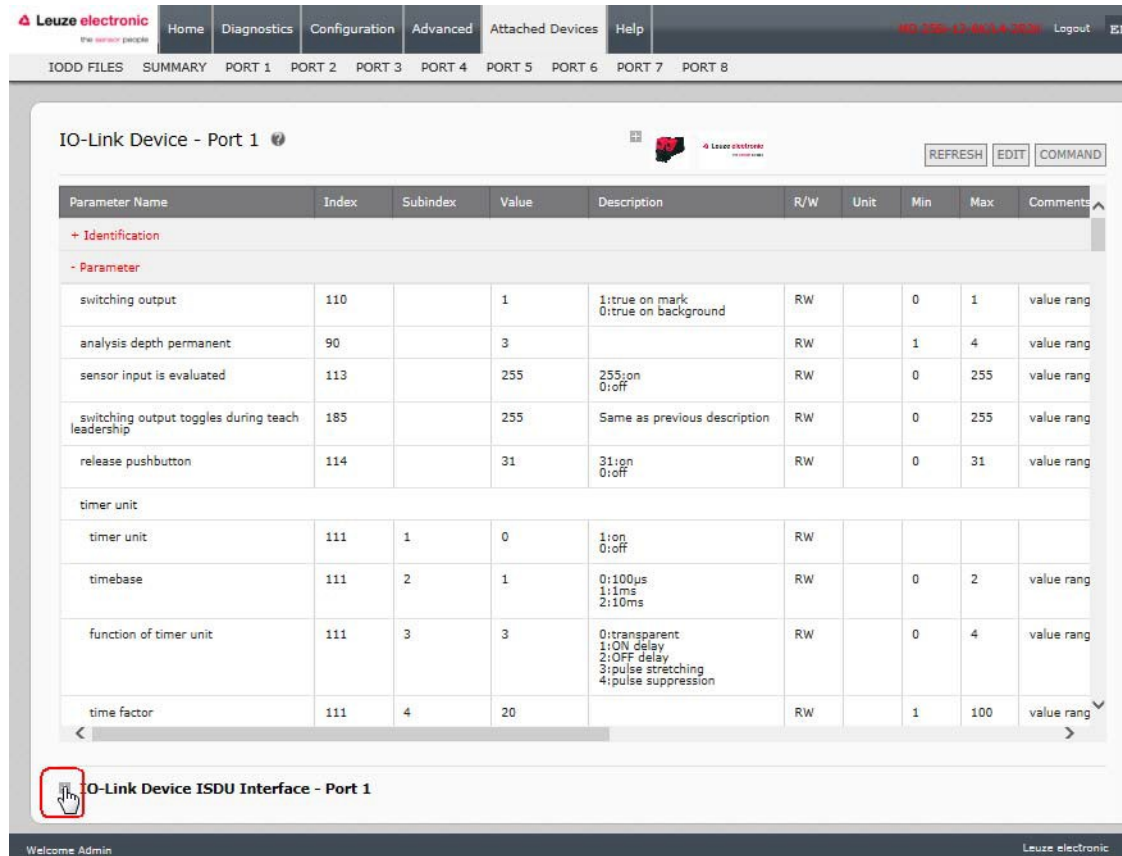
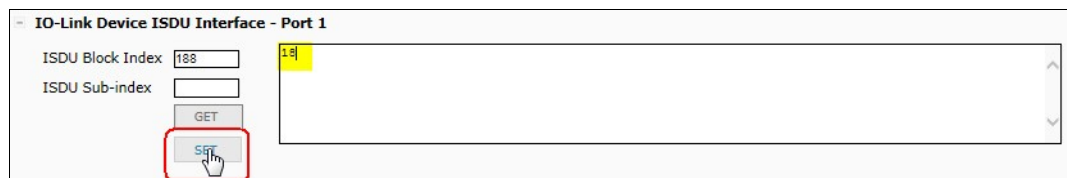

Figure 37: IO-Link iSDU interface

2. Enter the ISDU Block Index number (decimal) that you want to edit.
3. If applicable, enter the ISDU Sub-index (decimal).
4. Edit the parameter (hex) and click the **SET** button.



5. Verify that a *command executed* message returns.

6. If the IODD file is loaded, optionally click **REFRESH** to verify your changes.

The screenshot displays the Leuze electronic web interface for configuring an IO-Link device on Port 1. The main content area is titled "IO-Link Device - Port 1" and contains a table of configuration parameters. Below the table is the "IO-Link Device ISDU Interface - Port 1" section, which includes input fields for "ISDU Block Index" (set to 188) and "ISDU Sub-index", along with "GET" and "SET" buttons. A feedback window shows the message "command executed".

Parameter	Value 1	Value 2	Value 3	Description	Access	Min	Max	Unit	
time factor	111	4	20		RW	1	100	value rang	
- threshold levels									
position of switching point at ST1P, t each-level 1	188		24	24:very low sensitivity 20:low sensitivity 16:standard sensitivity 12:high sensitivity 8:very high sensitivity	RW	8	24	value rang	
position of switching point at ST1P, t each-level 2	189		8	Same as previous description	RW	8	24	value rang	
position of switching point at ST2P, t each-level 1	190		30	6:very close to the mark 12:close to the mark 25:toward mark 50:in the middle between the mark and background 70:in direction of the background 82:close to the background 90:very close to the background	RW	6	90	value rang 2;90	
position of switching point at ST2P, t each-level 2	191		12	Same as previous description	RW	6	90	value rang 2;90	
position of switching point at DT2P, t each-level 1	192		50	Same as previous description	RW	6	90	value rang 2;90	

IO-Link Device ISDU Interface - Port 1

ISDU Block Index: command executed

ISDU Sub-index:

Figure 38: IO-Link iSDU feedback

10 Utilizing IO-Link Master Features

This chapter discusses using the following features:

- *Data Storage - (automatic and manual) to upload or download IO-Link v1.1 device parameters, see Chapter 10.1*
- *Device Validation - (identical or compatible) to dedicate a port or ports to specific IO-Link devices, see Chapter 10.2*
- *Data Validation - (strict or loose) to verify data integrity, see Chapter 10.3*
- **Menu Bar Hover Shows Submenu**, which provides an option to navigate the submenu structure quickly, see Chapter 10.4.

10.1 Data Storage

Data storage is typically supported by IO-Link v1.1 devices. *Data storage* means that you can upload parameters from an IO-Link device to the IO-Link Master and/or download parameters from the IO-Link Master to the IO-Link device. This feature can be used to:

- Quickly and easily replace a defective IO-Link device
- Configure multiple IO-Link devices with the same parameters as fast as it takes to connect and disconnect the IO-Link device

To determine whether an IO-Link (v1.1) device supports data storage, you can check one of the following:

- **IO-Link Diagnostics** page - check the **Data Storage Capable** field to see if it displays **Yes**.
- **IO-Link Configuration** page - check to see if **UPLOAD** and **DOWNLOAD** buttons display under the **Data Storage Manual Ops** group.

If only a **Clear** button displays, the device on the port does not support data storage.

10.1.1 Uploading Data Storage to the IO-Link Master

The IO-Link device manufacturer determines which parameters are saved for data storage. Remember, the IO-Link device should be configured before enabling data storage unless you are using data storage to back up the default device configuration.

There are two methods to upload Data Storage using the **Configuration | IO-Link** page:

- **Automatic Enable Upload** - If a port is set to **On** for this option, the IO-Link Master saves the data storage (if the data storage is empty) from the IO-Link device to that port. Some IO-Link devices update the data storage contents if you use the Teach buttons on the IO-Link device, but that is determined by the IO-Link device manufacturer.

When this option is enabled and another IO-Link device (different Vendor ID and Device ID), the **IO-Link Diagnostics** page displays a *DV: Wrong Sensor* in the **IO-Link State** field and the IO-Link port LED flashes red, indicating a hardware fault.

Automatic upload occurs when the **Automatic Upload Enable** option is set to **On** and one of these conditions exists:

- There is no upload data stored on the gateway.
- The IO-Link device executes a **requests_ at upload** function (generally because you have changed the configuration via Teach buttons).

You should not enable **Automatic Upload** until after you have configured the IO-Link device attached to the port unless you want to capture the default settings.

Note: Do not enable both *Automatic Upload* and *Download* at the same time, the results are not reliable among IO-Link device manufacturers.

- **Data Storage Manual Ops: UPLOAD** - Selecting the **UPLOAD** button saves the data storage from the IO-Link device to that port. The content of the data storage does not change unless it is uploaded again or cleared. Another IO-Link device with a different Vendor ID and Device ID can be attached to the port without causing a hardware fault.

10.1.2 Downloading Data Storage to the IO-Link Device

There are two methods to download Data Storage using the **Configuration | IO-Link Device** page:

- **Automatic Download Enable** - An automatic download occurs when the Automatic Download Enable option is set to **On** and one of these conditions exists:
 - The original IO-Link device is disconnected and an IO-Link device who's configuration data differs from the stored configuration data.
 - The IO-Link device requests an upload and the **Automatic Upload Enable** option is set to **Off**.

Note: Do not enable both Automatic Upload and Download at the same time, the results are not reliable among IO-Link device manufacturers.
- **Data Storage Manual Ops: DOWNLOAD** - Selecting the **DOWNLOAD** button downloads the data storage from the port to the IO-Link device.

If an IO-Link device with a different Vendor ID and Device ID is attached to the port and a manual download is attempted, the IO-Link Master issues a hardware fault.

10.1.3 Automatic Device Configuration

Use the following steps to use an IO-Link Master port to configure multiple IO-Link devices with the same configuration parameters.

1. If necessary, configure the IO-Link device as required for the environment.
2. Click **Configuration| IO-Link**.
3. Click the **EDIT** button for the port for which you want to store the data on the IO-Link Master.
4. Click the **UPLOAD** button.

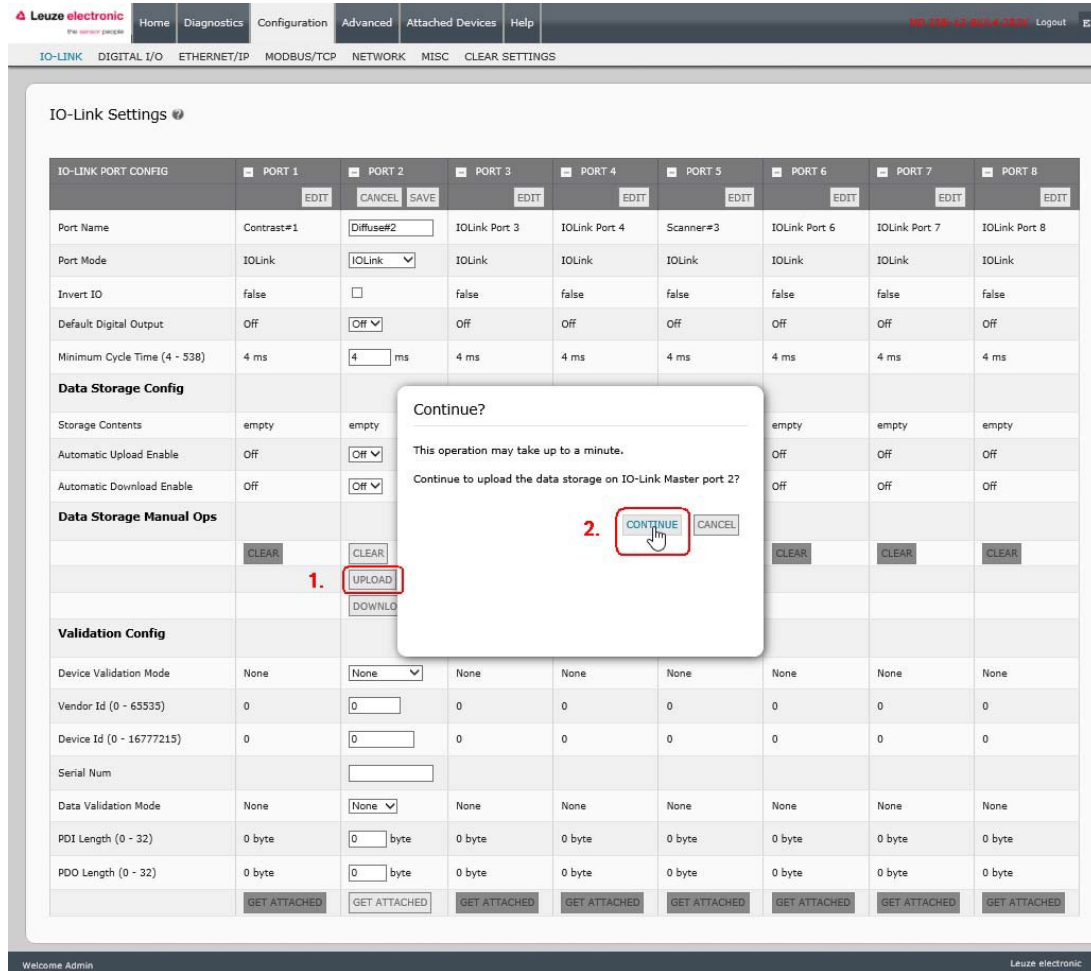

Figure 39: Data storage upload

5. Click the **CONTINUE** button to the *Continue to upload the data storage on IO-Link Master port [number]* message.
6. Click the **Ok** button to the *Data storage upload successful on Port [number]* message.

7. Set the **Automatic Download Enable** option to **On**.

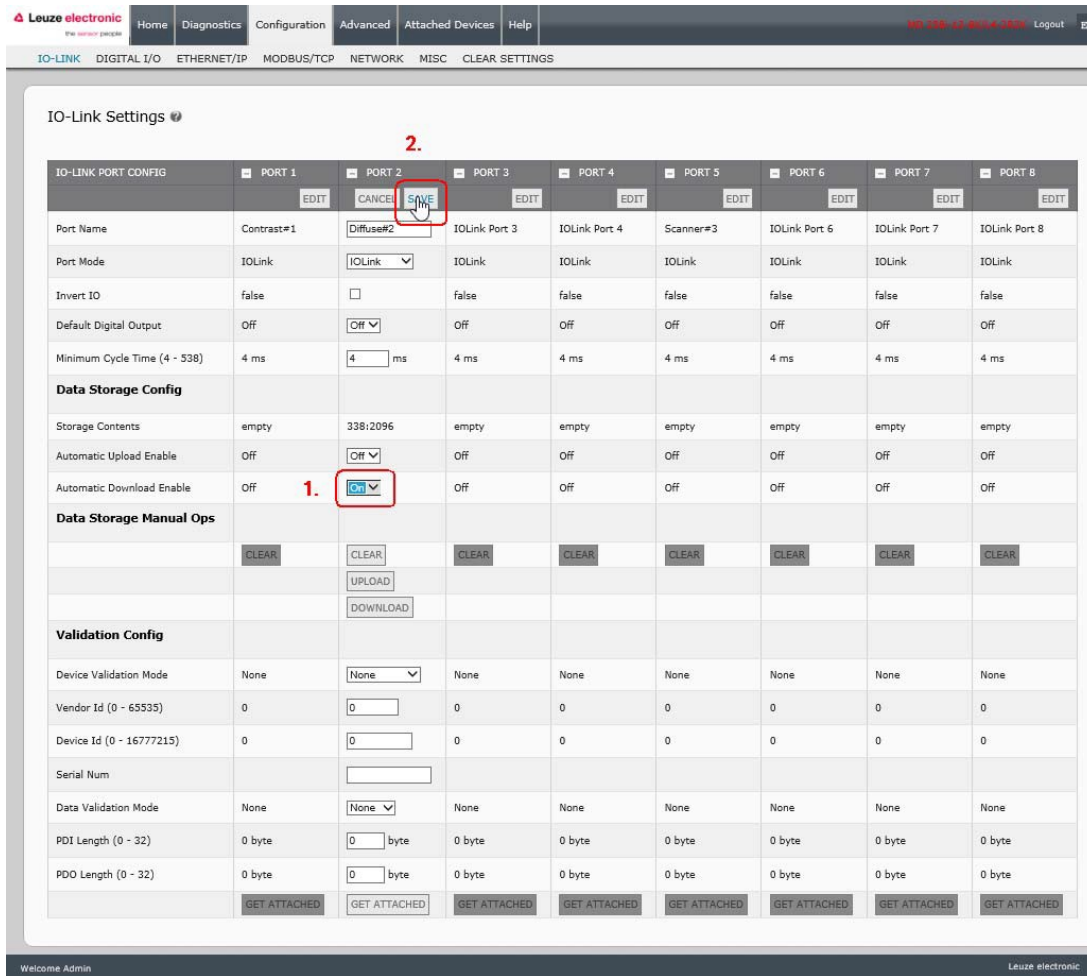

Figure 40: Data storage configuration

8. Click **SAVE**.
9. Click **Diagnostics | IO-Link**.
10. Replace the IO-Link device on that port with the IO-Link device for which you want configured automatically.
11. Verify that the IO-Link device displays operational **Port Status** and the appropriate IO-Link State.
12. Repeat Steps 10 and 11 for as many device as you want to configure.

10.1.4 Automatic Device Configuration Backup

The following procedure shows how to utilize data storage to automatically backup an IO-Link device configuration.

Remember, if you adjust parameters using **Teach** buttons those values may or not may be updated in the data storage, which depends on the IO-Link device manufacturer. If you are unsure, you can always use the manual **UPLOAD** feature to capture the latest settings.

1. Click **Configuration | IO-Link**.
2. Click the **EDIT** button for the port for which you want to store the data on the IO-Link Master.
3. Select **On** in the drop list for **Automatic Data Storage Upload Enable**.

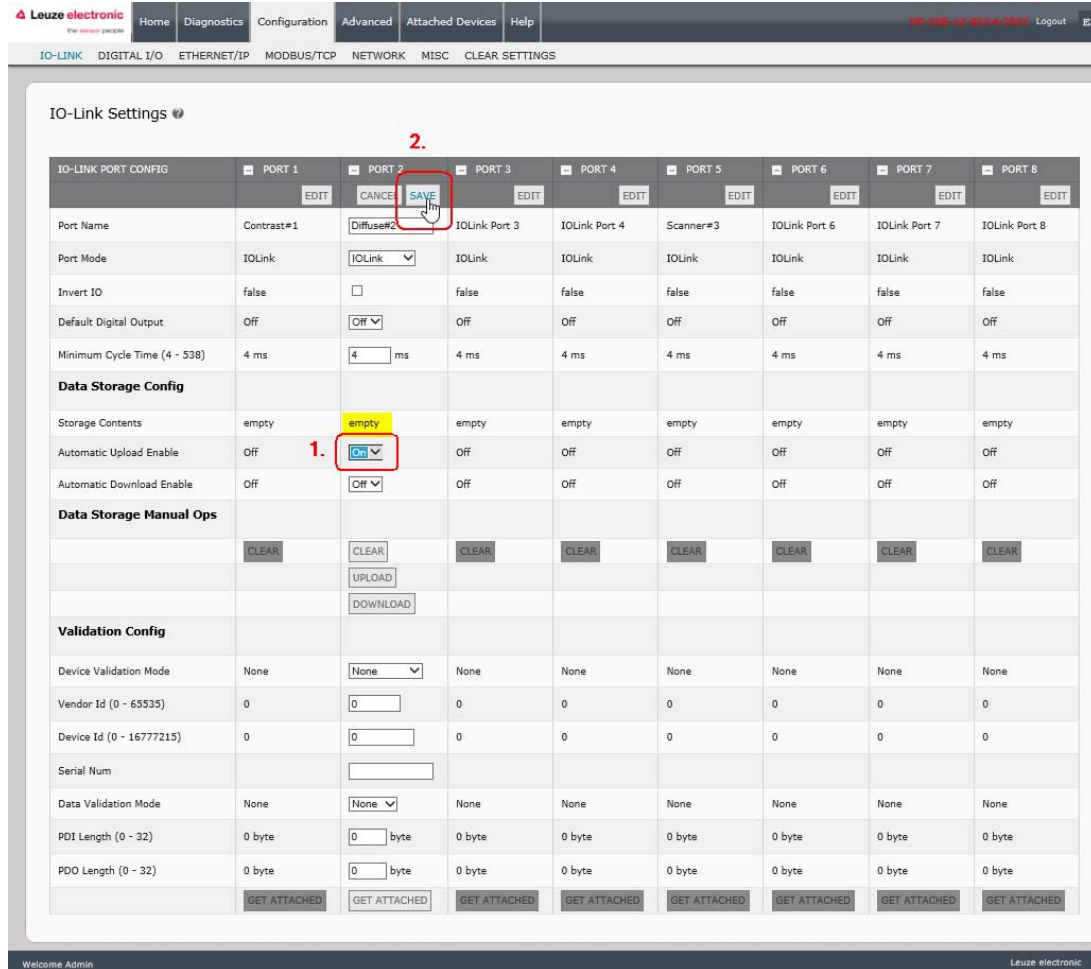

Figure 41: Activate automatic data storage upload

4. Click **SAVE**.

When the **Configuration | IO-Link** page is refreshed, the **Storage Contents** field displays the **Vendor ID** and **Device ID**. In addition, the **IO-Link Diagnostics** page displays **Upload-Only** in the **Automatic Data Storage Configuration** field.

10.2 Device Validation

Device validation is supported by many IO-Link devices. **Device Validation Mode** provides these options:

- **None** - this disables **Device Validation Mode**.
- **Compatible** - permits a compatible IO-Link device (same Vendor ID and Device ID) to function on the corresponding port.
- **Identical** - only permits an IO-Link device (same Vendor ID, Device ID, and serial number) to function on the corresponding port.

Use this procedure to configure device validation.

1. Click **Configuration | IO-Link Settings**.
2. Click the **EDIT** button.
3. Select **Compatible** or **Identical** for the **Device Validation** mode.

Note: Identical Device Validation requires a device serial number to operate.
4. Click the **GET ATTACHED** button or manually complete the Vendor ID, Device ID, and serial number.

If the device does not have a serial number, you should not select **Identical** because the IO-Link Master requires a serial number to identify a specific device.

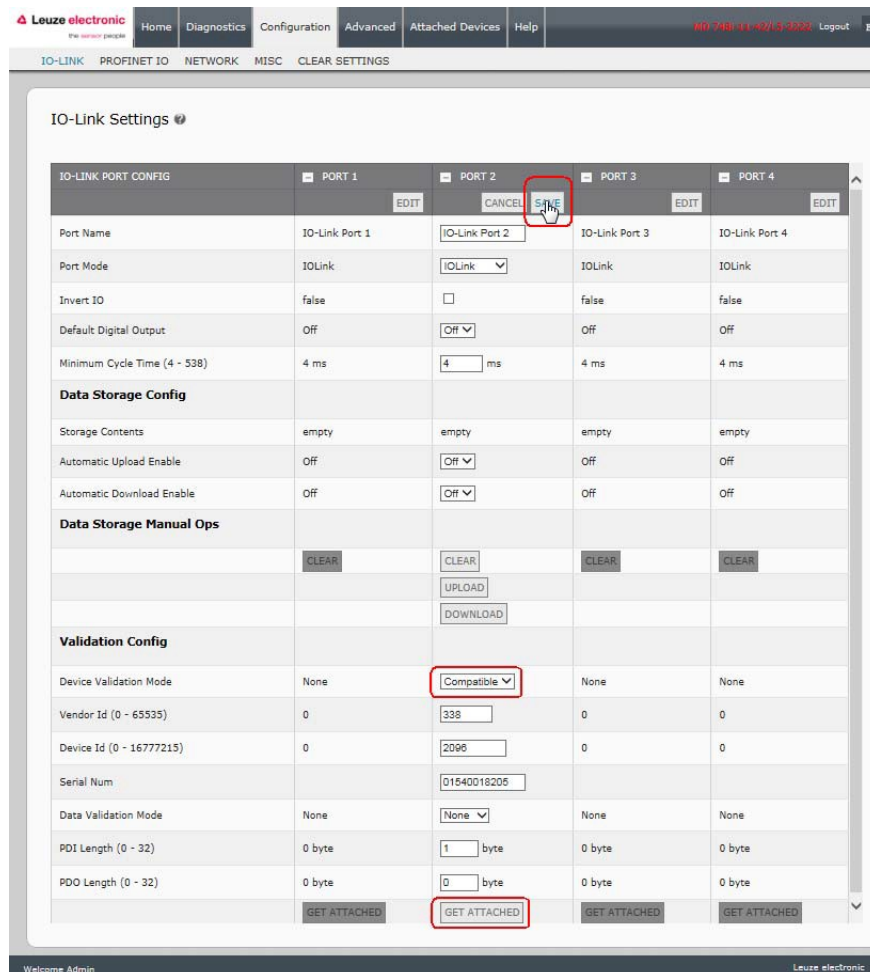

Figure 42: IO-Link device validation settings

- Click the **SAVE** button. If the wrong or incompatible device is connected to the port, the IO-Link port LED flashes red and no IO-Link activity occurs on the port until the issue is resolved. In addition, the **IO-Link Diagnostics** page displays the following information.

IO-LINK PORT STATUS	PORT 1	PORT 2	PORT 5
Port Name	Contrast#1	Diffuse#2	Scanner#3
Port Mode	IOLink	IOLink	IOLink
Port Status	Operational,PDI Valid	Inactive	Operational,PDI Valid
IOLink State	Operate	DV: WrongSensor	Operate
Device Vendor Name	Leuze electronic GmbH + Co. KG		Leuze electronic GmbH + Co. KG
Device Product Name	KRTL 3B/6.3111-58		HRTR 46B/L4.23-512
Device Serial Number	1408L068197		1111C000485
Device Hardware Version	L		C
Device Firmware Version	02.20		01.15
Device IO-Link Version	1.0		1.1
Actual Cycle Time	4.0 ms		0.0 ms
Device Minimum Cycle Time	2.5 ms		7.2 ms
Configured Minimum Cycle Time	4 ms	4 ms	4 ms
Data Storage Capable	No		No
Automatic Data Storage Configuration	Disabled	Upload-Only	Disabled
Auxiliary Input (AI) Bit Status	Off	Off	On
Device PDI Data Length	2		1
PDI Data Valid	Yes		Yes

Figure 43: IO-Link device validation

10.3 Data Validation

You can use this procedure to configure data validation.

1. Click **Configuration | IO-Link Settings**.
2. Click the **EDIT** button on the port you want to configure for data validation.
3. Select **Loose** or **Strict** to enable data validation.
 - **Loose** - the slave device's PDI/PDO lengths must be less than or equal to the user-configured values.
 - **Strict** - the slave device's PDI/PDO lengths must be the same as the user-configured values.
4. Click the **GET ATTACHED** button or manually enter the PDI and PDO length.

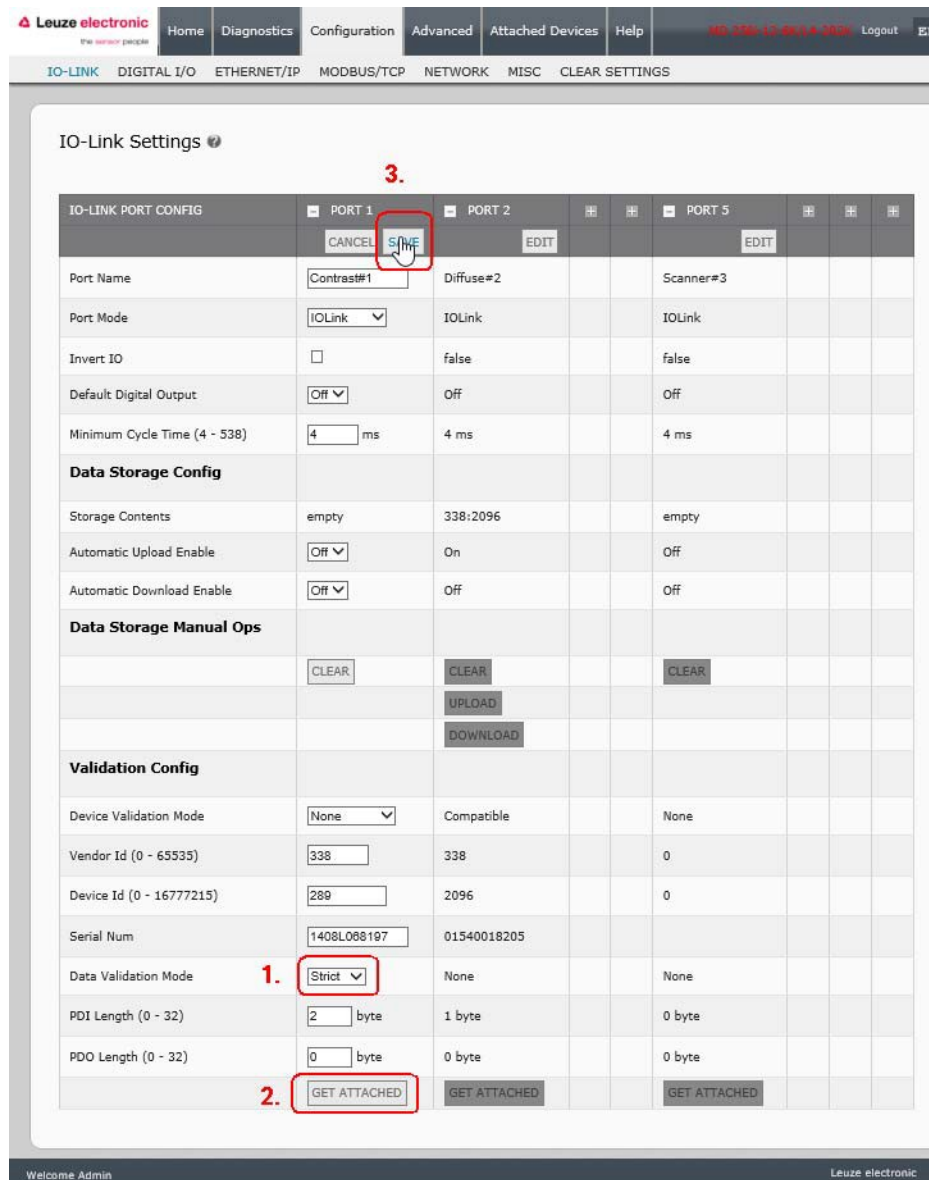

Figure 44: Upload device data for validation

5. Click the **SAVE** button.

If data validation fails, the IO-Link port LED flashes red and the **IO-Link Diagnostics** page displays an error.

10.4 Using the Menu Bar Hover Shows Submenu Option

Use this procedure to enable the **Menu Bar Hover Shows Submenu** option. If you enable this feature it displays the submenus for a category when you hover over the category name.

For example, if you hover over **Advanced**, the **SOFTWARE**, **ACCOUNTS**, **LOG FILES**, and **LICENSES** submenus display. You can click any submenu and avoid opening the default menu for a category.

1. Click **Configuration | MISC**.
2. Click the **EDIT** button.
3. Click **Enable** next to the **Menu Bar Hover Shows Submenu** option.
4. Click **SAVE**.

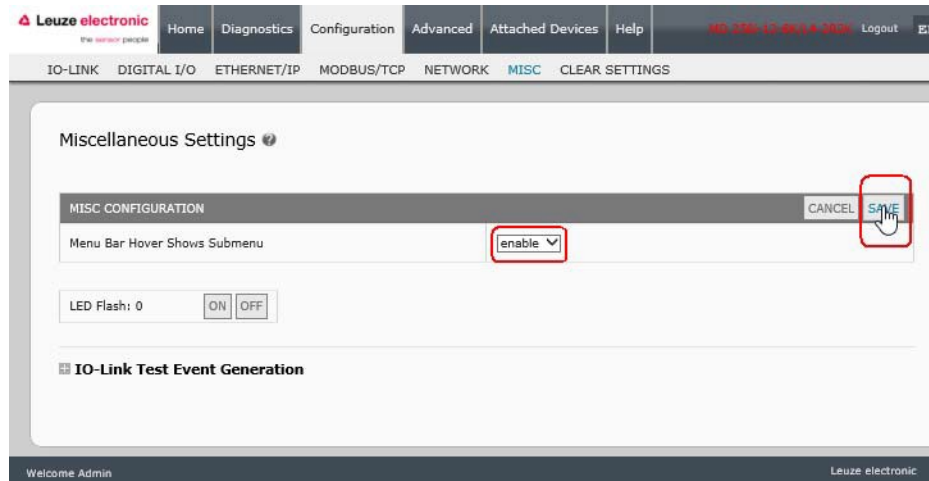

Figure 45: Save enable MISC settings

10.5 IO-Link Test Event Generator

You can use the **IO-Link Test Event Generator** to send messages through the IO-Link Master. The generated events are displayed in the **Diagnostics | IO-Link Settings** page under the **Last Events** field and the syslog.

IO-Link Test Event Generator Descriptions	
Port	The port number to which you want to send an event.
Mode	This is the first item in the event generated. <ul style="list-style-type: none"> • Single: generates Single in the event. • Coming: generates Active in the event • Going: generates Cleared in the event
Type	This is the second item in the event generated. <ul style="list-style-type: none"> • Message: generates Message in the event. • Warning: generates Warning in the event. • Error: generates Error in the event.
Instance	This is the level in which the event is generated. This is not displayed in the generated event. <ul style="list-style-type: none"> • unknown • physical • datalink • applayer • application

IO-Link Test Event Generator Descriptions	
Source	<p>This is the source in which the event is generated. This is the third item in the generated event.</p> <ul style="list-style-type: none"> • local: simulation generated from the IO-Link Master, which displays as Local in the event. • remote: simulation of an IO-Link device event, which displays as Device in the generated event.
PDI	<p>This indicates whether to send valid or invalid PDI, which is not displayed in the generated event.</p> <ul style="list-style-type: none"> • valid • invalid
Code	<p>This is the fourth and fifth items in the generated event.</p> <ul style="list-style-type: none"> • 0x0000: generates a s_pdu_check event • 0x0001: generates a s_pdu_flow event • 0x0002: generates a m_pdu_check event • 0x0003: generates a s_pdu_illegal event • 0x0004: generates a m_pdu_illegal event • 0x0005: generates a s_pdu_buffer event • 0x0006: generates a s_pdu_inkr event • 0x0007: generates an s_pd_len event • 0x0008: generates an s_no_pdin event • 0x0009: generates an s_no_pdout event • 0x000a: generates an s_channel event • 0x000b: generates an m_event event • 0x000c: generates an a_message event • 0x000d: generates an a_warning event • 0x000e: generates an a_device event • 0x000f: generates an a_parameter event • 0x0010: generates a devicelost event • 0x0011, 13 - 17: generates an unknown event • 0x0012: generates a s_desina event

11 Using the Diagnostics Pages

This chapter provides information about the following **Diagnostics** pages.

- *IO-Link Port Diagnostics, see Chapter 11.1*
- *Digital I/O Diagnostics (MD 258i-12-8K/L4-2R2K), see Chapter 11.2*
- *EtherNet/IP Diagnostics, see Chapter 11.3*
- *Modbus/TCP Diagnostics, see Chapter 11.4*

11.1 IO-Link Port Diagnostics

Use the **IO-Link Diagnostics** page to determine the status of the IO-Link configuration.

The screenshot shows the 'IO-Link Diagnostics' page with a table of diagnostic data for three ports. The table has columns for 'PORT 1', 'PORT 2', and 'PORT 5'. The data is as follows:

IO-LINK PORT STATUS	PORT 1	PORT 2	PORT 5
Port Name	Contrast#1	Diffuse#2	Scanner#3
Port Mode	IO-Link	IO-Link	IO-Link
Port Status	Operational,PDI Valid	Operational,PDI Valid	Operational,PDI Valid
IO-Link State	Operate	Operate	Operate
Device Vendor Name	Leuze electronic GmbH + Co. KG	Leuze electronic GmbH + Co. KG	Leuze electronic GmbH + Co. KG
Device Product Name	KRTL 3B/6.3111-58	HT10L1-25M.3/L69-M12	HRTR 46B/L4.23-S12
Device Serial Number	1408L068197	01540018205	1111C000485
Device Hardware Version	L	B000	C
Device Firmware Version	02.20	1.1	01.15
Device IO-Link Version	1.0	1.1	1.1
Actual Cycle Time	4.0 ms	4.0 ms	0.0 ms
Device Minimum Cycle Time	2.5 ms	2.3 ms	7.2 ms
Configured Minimum Cycle Time	4 ms	4 ms	4 ms
Data Storage Capable	No	Yes	No
Automatic Data Storage Configuration	Disabled	Upload-Only	Disabled
Auxiliary Input (AI) Bit Status	Off	Off	On
Device PDI Data Length	2	1	1
PDI Data Valid	Yes	Yes	Yes
Last Rx PDI Data (MS Byte First)	00h,0dh	19h	0bh
Device PDO Data Length	0	0	1
PDO Data Valid			No
Last Tx PDO Data (MS Byte First)			00h
Time Since Initialization	06m:38s.181ms	10m:02s.733ms	001d 00h:09m:21s.468ms
Lost Communication Count	1	3	1
Initialization Attempts	3	5	2
Initialization Errors	0	0	0

Figure 46: IO-Link diagnostic page

Note: The complete *IO-Link Diagnostics* page is not illustrated in this image.

The following table provides information about the **IO-Link Diagnostics** page.

IO-Link Diagnostics	
Port Name	This is an optional friendly port name, which can be configured in the Configuration IO-Link page.
Port Mode	Displays the active device mode: <ul style="list-style-type: none"> • Reset = The port is configured to disable all functionality. • IO-Link = The port is configured to IO-Link mode. • Digital In = The port is configured to operate as a digital input. • Digital Out = The port is configured to operate as a digital output.
Port Status	Displays the port status: <ul style="list-style-type: none"> • Inactive = The port is in active state. Typically, this indicates that the device is either not attached or not detected. • Initializing = The port is in the process of initializing. • Operational = The port is operational and, if in IO-Link mode, communications to the IO-Link device has been established. • PDI Valid = The PDI data is now valid. • Fault = The port has detected a fault and is unable to re-establish communications.
IO-Link State	<ul style="list-style-type: none"> • Operate - Port is functioning correctly in IO-Link mode but has not received valid PDI data. This may also display during a data storage upload or download. • Init - The port is attempting initialization. • Reset - One of the following conditions exists: <ul style="list-style-type: none"> • The Port Mode configuration is set to Reset. • The Port Mode configuration is set to DigitalIn or DigitalOut. • DS - Wrong Sensor - Hardware failure (IO-Link LED also flashes red) because there is Data Storage on this port, which does not reflect the attached device. • DV - Wrong Sensor - Hardware failure (IO-Link LED also flashes red) because Device Validation is configured for this port and the wrong device is attached. • DS - Wrong Size - Hardware failure (IO-Link LED also flashes red) because the size of the configuration on the device does not match the size of the configuration stored on the port. • Comm Lost - Temporary state after a device is disconnected and before the port is re-initialized. • Pre-operate - Temporary status displayed when the device: <ul style="list-style-type: none"> • Is starting up after connection or power-up. • Uploading or downloading automatic data storage.
Device Vendor Name	Displays the Device Vendor Name as stored in ISDU Index 16.
Device Product Name	Displays the device product name as stored in ISDU Index 18.
Device Serial Number	Displays the device serial number as stored in ISDU Index 21.
Device Hardware Version	Displays the device hardware version as stored in ISDU Index 22.
Device Firmware Version	Displays the device firmware version as stored in ISDU Index 23.

IO-Link Diagnostics	
Device IO-Link Version	The supported device IO-Link version as stored in ISDU Index 0.
Actual Cycle Time	This is the actual, or current, cycle time of the IO-Link connection to the device.
Device Minimum Cycle Time	This is the minimum, or fastest, cycle time supported by the connected IO-Link device.
Configured Minimum Cycle Time	Configured in the Configuration IO-Link page, this is the minimum cycle time the IO-Link Master will allow the port to operate at. The Actual Cycle Time , which is negotiated between the IO-Link Master and the device, will be at least as long as the greater of the Configured Minimum Cycle Time and the Device Minimum Cycle Time .
Data Storage Capable	Displays whether the IO-Link device on a port supports the data storage feature. Not all IO-Link devices support the data storage feature.
Automatic Data Storage Configuration	Displays whether a port is configured to automatically upload data from the IO-Link device or download data from the IO-Link Master to the IO-Link device. Disabled displays if automatic upload or download are not enabled.
Auxiliary Input (AI) Bit Status	The current status of the auxiliary bit as received on DI (Pin 2 on the MD 758i-11-42/L5-2222) of the IO-Link port.
Device PDI Data Length	The supported Device PDI Data Length, in bytes, as stored in ISDU Index 0.
PDI Data Valid	Current status of PDI data as received from the IO-Link device.
Last Rx PDI Data (MS Byte First)	The last Rx PDI data as received from the IO-Link device.
Device PDO Data Length	The supported Device PDO Data Length, in bytes, as stored in ISDU Index 0.
PDO Data Valid	Status of PDO data being received from controller(s).
Last Tx PDO Data (MS Byte First)	The last Tx PDO data.
Time Since Initialization	The time since the last port initialization.
Process Data Errors	The number of process data errors the port received.
Process Data Retries	The number of process data retries the port performed.
Total Events	The total number of events that were received on this port.
First Events	Up to the first, or oldest, three events that were received on this port.
Last Events	Up to the last, or most recent, three events that were received on this port.
ISDU Statistics	
ISDU Read Cmd Attempts	The number of read ISDU command attempts.
ISDU Read Cmd Errors	The number of read ISDU command errors.
ISDU Write Cmd Attempts	The number of write ISDU command attempts.
ISDU Write Cmd Errors	The number of write ISDU command errors.

11.2 Digital I/O Diagnostics (MD 258i-12-8K/L4-2R2K)

The **Digital I/O Diagnostics** page may be useful when trying to troubleshoot port issues related to configuration.

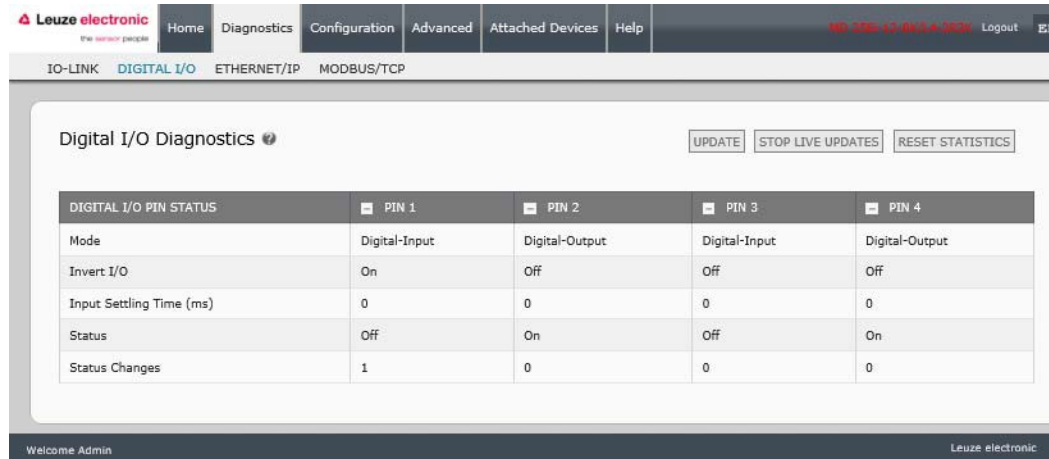

Figure 47: Digital I/O diagnostic page

The following table provides information about the **Digital I/O Diagnostics** page.

Digital I/O Diagnostics	
Mode	Displays the current configured operating mode of the digital I/O pin. <ul style="list-style-type: none"> • Off • Digital-Input • Digital-Output (Pins D2 and D4 only)
Invert I/O	Displays the current configured Invert I/O setting: <ul style="list-style-type: none"> • On (Invert I/O) • Off (Do not invert I/O)
Input Settling Time (ms)	Displays the current configured input settling time.
Status	Displays the current status of the digital I/O pin. <ul style="list-style-type: none"> • On (high voltage) • Off (low voltage)
Status Changes	Displays the number of times that the status of the digital I/O pin has changed.

11.3 EtherNet/IP Diagnostics

The **EtherNet/IP Diagnostics** page may be useful when trying to troubleshoot EtherNet/IP communications and port issues related to EtherNet/IP configuration.

ETHERNET/IP GENERAL STATUS

Active Session Count	0
Active Connections	0
Total Connections Established	0
Connection Timeouts	0
Connections Closed	0
Class 3 Messages/Responses Received	0
Broadcast Messages Received	9874
Class 3 Messages/Responses Transmitted	9872
Class 1 Output Updates (From PLC)	0
Class 1 Output Data Changes (From PLC)	0
Class 1 Input Updates (To PLC)	0
Client Object Requests	0
Good Responses from PLC	0
Bad Responses from PLC	0
No Responses From PLC	0
Invalid Network Paths	0
Pending Request Limit Reached	0
Unexpected Events	0
Unsupported CIP Class Errors	0
Unsupported CIP Instance Errors	0
Unsupported CIP Service Errors	0
Unsupported CIP Attribute Errors	0
Unsupported File Errors	0
System Resource Errors	0
First Error String	No Error Detected
Last Error String	

ETHERNET/IP PORT STATUS

	PORT 1	PORT 2	PORT 3	PORT 4	PORT 5	PORT 6	PORT 7	PORT 8
Configuration Errors	0	0	0	0	0	0	0	0
Invalid Data Errors	0	0	0	0	0	0	0	0

Figure 48: EtherNet/IP Diagnostics page

Note: The complete *EtherNet/IP Diagnostics page* is not illustrated.

The following table provides information about the **EtherNet/IP Diagnostics** page.

EtherNet/IP Diagnostics	
Active Session Count	The number of active Ethernet/IP sessions. A session can: <ul style="list-style-type: none"> • Support both Class 1 I/O and Class 3 Messages • Can be initiated by either the PLC or the IO-Link Master • Can be terminated by either the PLC or the IO-Link Master
Active Connections	The current number of active connections (both Class 1 and 3).
Total Connections Established	The total number of connections that have been established.
Connection Timeouts	The number of connections that have closed due to timing out.
Connections Closed	The number connections that have closed due to a standard processes.
Class 3 Messages/ Responses Received	The number of Class 3 messages and responses received from the PLC or PLCs.
Broadcast Messages Received	The number of broadcast messages received from PLC or PLCs.
Class 3 Messages/ Responses Transmitted	The number of Class 3 messages and responses sent to the PLC or PLCs.
Class 1 Output Updates (From PLC)	The number of Class 1 output data updates received from the PLC or PLCs.
Class 1 Output Data Changes (From PLC)	The number of changes in Class 1 output data received from the PLC.
Class 1 Input Data Updates (To PLC)	The number of Class 1 input data updates sent to the PLC or PLCs.
Client Object Requests	The number of Class 3 requests to the IO-Link Master vendor specific objects.
Good Responses from PLC	The number of good responses from messages sent to PLC or PLCs.
Bad Responses from PLC	Displays the number of bad responses from messages sent to the PLC or PLCs. Bad responses are typically returned for such errors as: <ul style="list-style-type: none"> • Incorrect tag or file names • Incorrect tag or file data types • Incorrect tag or file data sizes • PLC is overloaded and cannot handle the amount of Ethernet traffic • PLC malfunction
No Responses from PLC	Displays the number of no responses from messages sent to the PLC or PLCs. No responses are typically returned for such errors as: <ul style="list-style-type: none"> • Incorrect IP address • Incorrect PLC configuration • PLC malfunction • PLC is overloaded and cannot handle the amount of Ethernet traffic
Invalid Network Paths	Displays the number of network path errors on messages sent to the PLC or PLCs. These are typically caused by incorrect IP address settings.
Pending Request Limit Reached	Displays the number of pending request limit errors. These errors occur when the PLC is sending a continuous stream of messages to the IO-Link Master faster than the IO-Link Master can process them.

EtherNet/IP Diagnostics	
Unexpected Events	Displays the number of unexpected event errors. Unexpected event errors occur when the IO-Link Master receives an unexpected message from the PLC such as an unexpected response or unknown message.
Unsupported CIP Class Errors	Displays the number of unsupported CIP class errors. These errors occur when a message that attempts to access an invalid class is received by the IO-Link Master.
Unsupported CIP Instance Errors	Displays the number of unsupported CIP instance errors. These errors occur when a message that attempts to access an invalid instance is received by the IO-Link Master.
Unsupported CIP Service Errors	Displays the number of unsupported CIP service errors. These errors occur when a message that attempts to access an invalid service is sent to the IO-Link Master.
Unsupported CIP Attribute Errors	Displays the number of unsupported CIP request attribute errors. These errors occur when a message that attempts to access an invalid attribute is sent to the IO-Link Master.
Unsupported File Errors	Displays the number of messages from SLC/PLC-5/MicroLogix PLCs that attempt to access an unsupported file address.
System Resource Errors	Displays the number of system resource errors. These errors indicate a system error on the IO-Link Master such as operating system errors or full message queues. These errors typically occur when the PLC or PLCs are sending messages to the IO-Link Master faster than the IO-Link Master can process them.
First Error String	Text description of the first error that occurred.
Last Error String	Text description of the last error that occurred.
<i>EtherNet/IP Port Specific Diagnostics</i>	
Configuration Errors	Displays the number of improper configuration errors. These errors occur when the IO-Link Master receives a message that cannot be performed due to an invalid configuration.
Invalid Data Errors	Displays the number of invalid message data errors. These errors occur when the IO-Link Master receives a message that cannot be performed due to invalid data.
Active PDO Controller(s)	Lists the controller interface(s) type, (Class 1 or Class 3), and IP address that are controlling the PDO data.
PDO Writes to Offline or Read-Only Ports	Displays the number of PDO write messages that were dropped due to any of the following: <ul style="list-style-type: none"> • The port is configured in IO-Link mode: <ul style="list-style-type: none"> • There is no device connected to the port. • The IO-Link device is off-line. • The IO-Link device does not support PDO data. • The PDO Transmit Mode (To PLC) is disabled. • The port is configured in Digital Input mode.
Undeliverable PDI Updates (To PLC)	Displays the number of PDI update messages that could not be delivered to the PLC in the Write-to-Tag/File method. Undeliverable updates may result when: The IO-Link Master cannot complete an Ethernet connection to the PLC. The PDI data is changing faster than the Maximum PLC Update Rate .
ISDU Request Msgs From PLC(s)	Displays the number of ISDU request messages received from the PLC(s) or other controllers. These request messages may contain one or multiple ISDU commands.

EtherNet/IP Diagnostics	
ISDU Invalid Requests	Displays the number of ISDU requests received over EtherNet/IP with one or more invalid commands.
ISDU Requests When Port Offline	Displays the number of ISDU requests received over EtherNet/IP when the IO-Link port was offline. This can occur when: <ul style="list-style-type: none"> • The IO-Link port is initializing, such as after start-up. • There is no IO-Link device attached to the port. • The IO-Link device is not responding. • Communication to the IO-Link device has been lost.
Valid ISDU Responses From Port	Displays the number of valid ISDU response messages returned from the IO- Link port interface and available to the PLC(s). The response messages contain results to the ISDU command(s) received in the request message.
ISDU Response Timeouts	Displays the number of ISDU requests that did not receive a response within the configured ISDU Response Timeout .
Unexpected ISDU Responses	Displays the number of unexpected ISDU responses. Unexpected responses may occur when an ISDU response is received after the ISDU request has timed out. This typically requires setting the ISDU Response Timeout to a longer value.
ISDU Read Commands	Displays the number of ISDU read commands received over EtherNet/IP.
Maximum ISDU Request Msg Response Time	Displays the maximum time period required to process all commands within an ISDU request message. The response is not available until all ISDU command(s) contained in the request have been processed.
Average ISDU Request Msg Response Time	Displays the average time period required to process the ISDU request message(s). The response is not available until all ISDU command(s) contained in the request have been processed.
Minimum ISDU Request Msg Response Time	Displays the minimum time period required to process all commands within an ISDU request message. The response is not available until all ISDU command(s) contained in the request have been processed.
ISDU Write Commands	Displays the number of ISDU write commands received over EtherNet/IP.
ISDU NOP Commands	Displays the number of ISDU NOP (no operation) commands received over EtherNet/IP.

11.4 Modbus/TCP Diagnostics

The **Modbus/TCP Diagnostics** page may be useful when trying to troubleshoot Modbus/TCP communications or port issues related to Modbus/TCP configuration

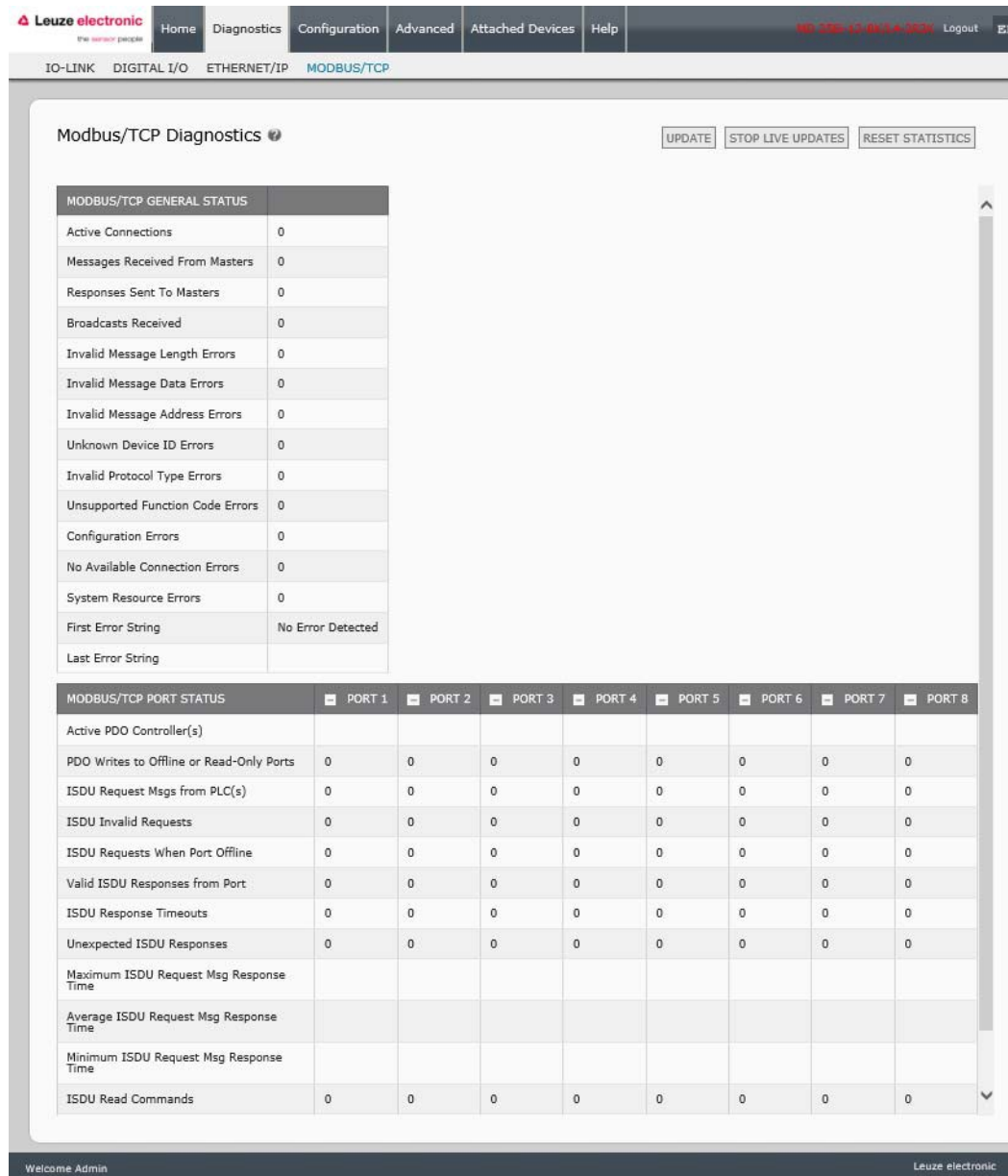

Figure 49: Modbus/TCP diagnostics page

Note: The complete Modbus/TCP Diagnostics page is not illustrated.

The following table provides information about the **Modbus/TCP Diagnostics** page.

Modbus/TCP Diagnostics	
Active Connections	Displays the current number of active Modbus/TCP connections.
Messages Received from Masters	Displays the number of Modbus messages received from Modbus/TCP Masters.
Responses Sent to Masters	Displays the number of Modbus responses sent to Modbus/TCP Masters.
Broadcasts Received	Displays the number of broadcast Modbus/TCP messages received.
Invalid Message Length Errors	Displays the number of Modbus messages received with incorrect length fields.
Invalid Message Data Errors	Displays the number of invalid message data errors. These errors occur when the IO-Link Master receives a message that cannot be performed due to invalid data.
Invalid Message Address Errors	Displays the number of invalid message address errors. These errors occur when the IO-Link Master receives a message that cannot be performed due to an invalid address.
Unknown Device ID Errors	Displays the number of unknown device ID errors. These errors occur when the IO-Link Master receives a message that is addressed to a device ID other than the configured Slave Mode Device ID .
Invalid Protocol Type Errors	Displays the number of invalid message protocol type errors. These errors occur when the IO-Link Master receives a Modbus/TCP message that specifies a non-Modbus protocol.
Unsupported Function Code Errors	Displays the number of invalid Modbus function code errors. These errors occur when the IO-Link Master receives a message that cannot be performed due to an unsupported Modbus function code.
Configuration Errors	Displays the number of improper configuration errors. These errors occur when the IO-Link Master receives a message that cannot be performed due to an invalid configuration.
No Available Connection Errors	Displays the number of Modbus/TCP connection attempts that were rejected due to no available connections. This occurs when the number of Modbus/TCP connections has reached the limit.
System Resource Errors	Displays the number of system resource errors. These errors indicate a system error on the IO-Link such as operating system errors or full message queues. These errors typically occur when the PLC(s) are sending messages to the IO-Link Master faster than the IO-Link Master can process them.
First Error String	Text description of the first error that occurred.
Last Error String	Text description of the last error that occurred.

Modbus/TCP Diagnostics	
<i>Modbus/TCP Port Specific Diagnostics</i>	
Active PDO Controller(s)	Lists the controller interface(s) type, (Class 1 or Class 3), and IP address that are controlling the PDO data.
PDO Writes to Offline or Read-Only Ports	Displays the number of PDO write messages that were dropped due to any of the following: <ul style="list-style-type: none"> • The port is configured in IO-Link mode: <ul style="list-style-type: none"> • There is no device connected to the port. • The IO-Link device is off-line. • The IO-Link device does not support PDO data. • The PDO Transmit Mode (To PLC) is disabled. • The port is configured in Digital Input mode.
ISDU Request Msgs From PLC(s)	Displays the number of ISDU request messages received from the PLC(s) or other controllers. These request messages may contain one or multiple ISDU commands.
ISDU Invalid Requests	Displays the number of ISDU requests received over Modbus/TCP with one or more invalid commands.
ISDU Requests When Port Offline	Displays the number of ISDU requests received over Modbus/TCP when the IO-Link port was offline. This can occur when: <ul style="list-style-type: none"> • The IO-Link port is initializing, such as after start-up. • There is no IO-Link device attached to the port. • The IO-Link device is not responding. • Communication to the IO-Link device has been lost.
Valid ISDU Responses From Port	Displays the number of valid ISDU response messages returned from the IO-Link port interface and available to the PLC(s). The response messages contain results to the ISDU command(s) received in the request message.
ISDU Response Timeouts	Displays the number of ISDU requests that did not receive a response within the configured ISDU Response Timeout .
Unexpected ISDU Responses	Displays the number of unexpected ISDU responses. Unexpected responses may occur when an ISDU response is received after the ISDU request has timed out. This typically requires setting the ISDU Response Timeout to a longer value.
Maximum ISDU Request Msg Response Time	Displays the maximum time period required to process all commands within an ISDU request message. The response is not available until all ISDU command(s) contained in the request have been processed.
Average ISDU Request Msg Response Time	Displays the average time period required to process the ISDU request message(s). The response is not available until all ISDU command(s) contained in the request have been processed.
Minimum ISDU Request Msg Response Time	Displays the minimum time period required to process all commands within an ISDU request message. The response is not available until all ISDU command(s) contained in the request have been processed.
ISDU Read Commands	Displays the number of ISDU read commands received over Modbus/TCP.
ISDU Write Commands	Displays the number of ISDU write commands received over Modbus/TCP.
ISDU NOP Commands	Displays the number of ISDU NOP (no operation) commands received over Modbus/TCP.

12 EtherNet/IP Interface

12.1 Introduction

This chapter is intended to describe the EtherNet/IP and Modbus/TCP interfaces provided by the IO-Link Master.

These interfaces provide the ability to retrieve port and device status information, input and output process data and access to IO-Link device ISDU (SPDU) data blocks.

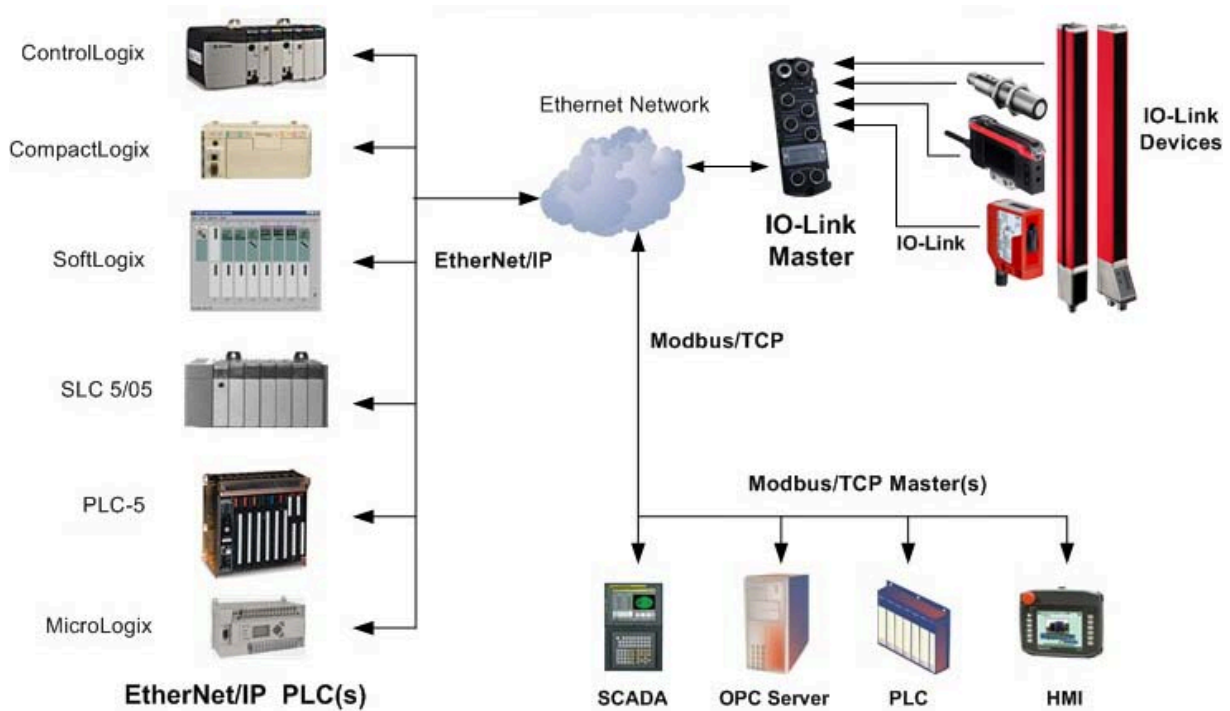

Figure 50: IO-Link Master Connectivity

12.1.1 Functionality Summary

The EtherNet/IP interface consists of:

- Input Process Data blocks that include:
 - Port communication status
 - PDI valid status
 - Auxiliary Input status of IO-Link connector (DI on the MD 258i-12-8K/L4-2R2K)
 - The active event code (zero if no active event)
 - The input process data received from the port. This may be
 - IO-Link mode: IO-Link device input process data
 - I/O Input mode: Input bit status
 - I/O Output mode: Output bit status (configurable option)
- Output Process Data blocks that include:
 - The active event code to clear ((configurable option)
 - The output process data to be sent to the port. This may be
 - IO-Link mode: IO-Link device output process data
 - I/O Output mode: Output bit status

- ISDU (ISDU) interface:
 - Provides single and nested batch read/write capabilities
 - Requires use of MSG instructions
 - Provides both blocking and non-blocking message capabilities
 - Blocking message responses are not returned until all the ISDU command(s) have completed.
 - Non-blocking messages return immediately. The PLC must then request the ISDU command(s) response status until a valid response is returned.
- Web based configuration and diagnostic pages:
 - IO-Link interface configuration and diagnostics
 - EtherNet/IP interface configuration and diagnostics
- EtherNet/IP interface support for ControlLogix, SLC, MicroLogix, and PLC-5 PLC families.
- Modbus/TCP slave interface.
- Example PLC programs to aid the PLC programmer.

12.1.2 Data Type Definitions

The following data type definitions apply.

Data Type Definitions	
BOOL	Boolean; TRUE if = 1; False if = 0
USINT	Unsigned Short Integer (8 bit)
CHAR	Character (8 bit)
SINT	Short Integer (8 bit)
UINT	Unsigned Integer (16 bit)
INT	Signed Integer (16 bit)
UDINT	Unsigned Double Integer (32 bit)
DINT	Signed Double Integer (32 bit)
STRING	Character String (1 byte per character)
BYTE	Bit String (8 bit)
WORD	Bit String (16 bits)
DWORD	Bit String (32 bits)

12.1.3 Terms and Definitions

This section uses the following terms and definitions.

Term	Definition
Class 1	<p>Otherwise called implicit messaging, is a method of communication between EtherNet/IP controllers and devices that:</p> <ul style="list-style-type: none"> • Uses Ethernet UDP messages. • Is cyclic in nature. Input and/or output data is exchanged between the controllers and devices at regular time intervals.
Class 3	<p>Otherwise called explicit messaging, is a method of communication between EtherNet/IP controllers and devices that:</p> <ul style="list-style-type: none"> • Uses Ethernet TCP/IP messages. • By itself is not cyclic in nature. The controller and devices must send individual messages to each other.
EtherNet/IP	An Ethernet based industrial communication protocol utilized to communicate between controllers, often times PLCs, and devices.
Ethernet TCP/IP	Standard Ethernet communications protocol utilizing socket communication interfaces that guarantees delivery to the intended device.
Ethernet UDP/IP	Standard Ethernet communications protocol utilizing socket communication interfaces that does not guarantee delivery . The data may or may get to the intended device.
IO-Link Master	IO-Link gateway that provides communication between IO-Link devices and Ethernet protocols such as EtherNet/IP and Modbus/TCP.
Multicast	<p>Multicast addressing involves Ethernet devices sending messages to each other using a multicast address. Multicast addressing:</p> <ul style="list-style-type: none"> • Uses a specified IP address range designated for multicast communication. • Allows either one or multiple devices to receive the same messages.
Point-to-Point	Point-to-Point, otherwise called unicast , addressing involves Ethernet devices sending messages directly to each other using their own IP addresses. Messages are sent to only one device.
PDI data (Process Data Input)	Process data received from an IO-Link device or I/O interface that can be provided to external controllers such as PLCs, HMIs, SCADA, and OPC Servers.
PDO data (Process Data Output)	<p>Process data received from external controllers such as PLCs, HMIs, SCADA, and OPC Servers and sent to an IO-Link device or I/O interface.</p> <p>Note: <i>O-Link devices may or may not support PDO data.</i></p>
ISDU	Indexed Service Data Unit. Otherwise called ISDU, refers to the Service Data units on IO-Link devices that are used for information, status and configuration settings.
Class 1	<p>Otherwise called implicit messaging, is a method of communication between EtherNet/IP controllers and devices that:</p> <ul style="list-style-type: none"> • Uses Ethernet UDP messages. • Is cyclic in nature. Input and/or output data is exchanged between the controllers and devices at regular time intervals.

12.2 Data Transfer Methods

The IO-Link Master provides a selection of process data transfer methods and a number of options to customize the process data handling.

- *Receive Process Data Methods, see Chapter 12.2.1*
- *Transmit Process Data Methods, see Chapter 12.2.2*

12.2.1 Receive Process Data Methods

The IO-Link Master supports the following receive process data methods:

- *Polling-PLC Requests Data, see Chapter 12.2.1.1*
- *Write-to-Tag/File-IO-Link Master Writes Data Directly Into PLC Memory, see Chapter 12.2.1.2*
- *Class 1 Connection (Input Only)-PLC and IO-Link Master Utilize an I/O Connection, see Chapter 12.2.1.3*

12.2.1.1 Polling-PLC Requests Data

Also called *Slave-Mode* for some industrial protocols, the polling method requires the controller to request data from the IO-Link Master via messages. The IO-Link Master does not respond until it receives a request for data.

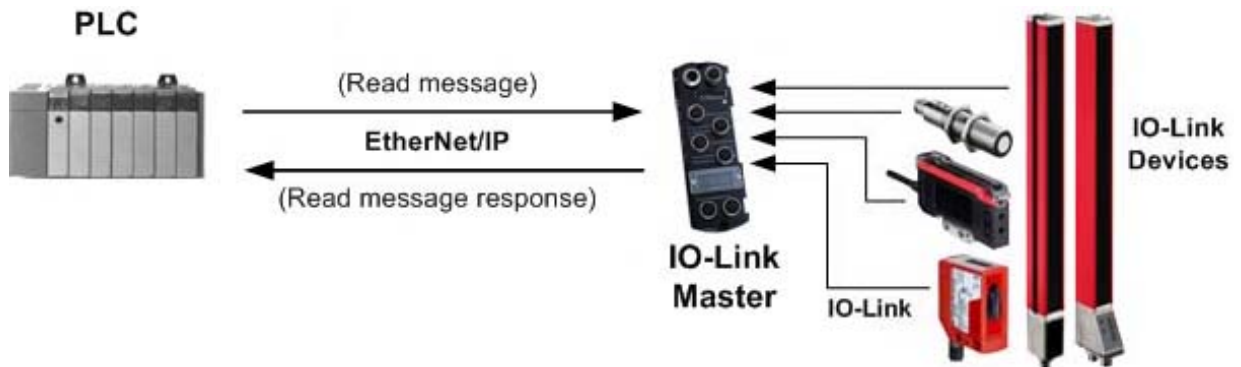

Figure 51: Polling Rx Transfer Method

12.2.1.2 Write-to-Tag/File-IO-Link Master Writes Data Directly Into PLC Memory

Also called *Master-Mode* for some industrial protocols, the Write-to-Tag/File method requires the IO-Link Master to send messages that write data directly into a tag or file on the PLC. The IO-Link Master sends changed data to the PLC immediately and, optionally, can be configured to also send “heartbeat” update messages at a regular time interval.

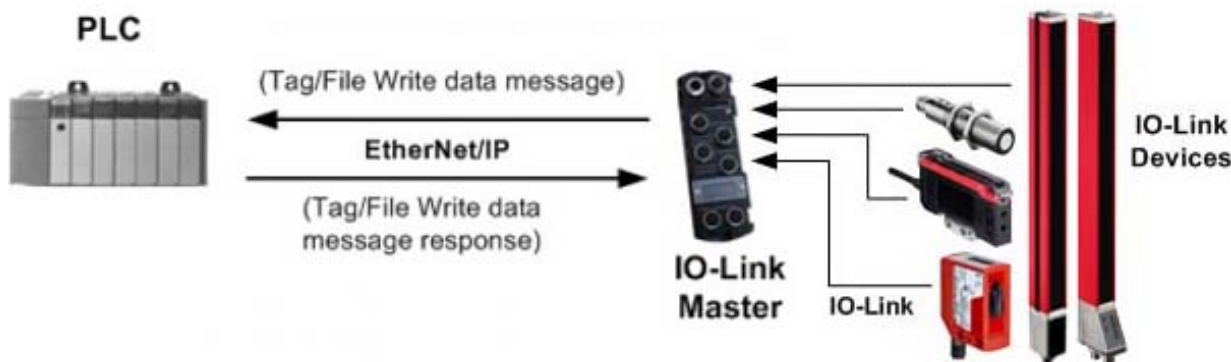

Figure 52: Write-to-Tag/File Rx Transfer Method

12.2.1.3 Class 1 Connection (Input Only)-PLC and IO-Link Master Utilize an I/O Connection

Also called *I/O Mode* for some industrial protocols, the Class 1 connection method requires the IO-Link Master and PLC to connect to each via an I/O connection. For EtherNet/IP, a connection over UDP must first be created. Once the connection is established, the IO-Link Master continually sends input data to the PLC at a PLC configurable rate.

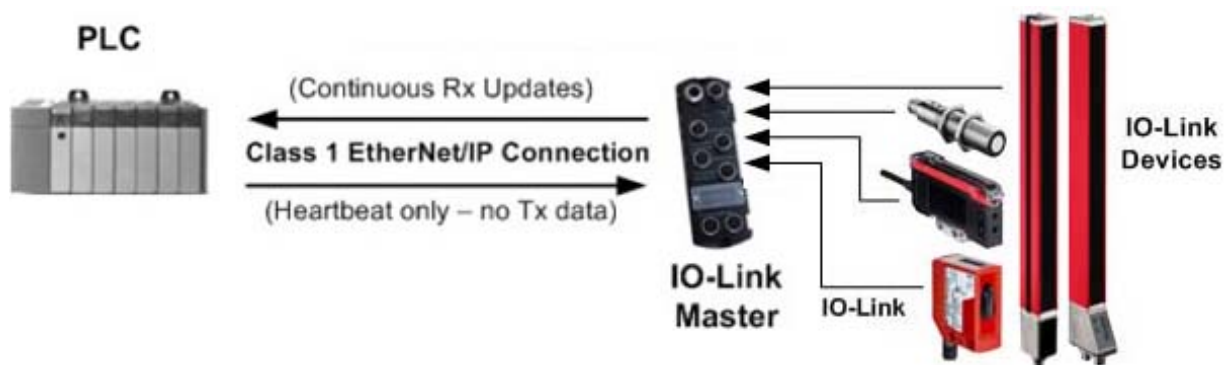

Figure 53: Class 1 Rx Transfer Method

12.2.2 Transmit Process Data Methods

The IO-Link Master supports the following transmit process data methods:

- *PLC-Writes*, see Chapter 12.2.2.1
- *Read-from-Tag/File-IO-Link Master Reads Data from PLC Memory*, see Chapter 12.2.2.2
- *Class 1 Connection (Input and Output)-PLC and IO-Link Master Utilize an I/O Connection*, see Chapter 12.2.2.3

12.2.2.1 PLC-Writes

Also called *Slave-Mode* for some industrial protocols, the PLC-Writes method requires the PLC to send data to the IO-Link Master via write messages.

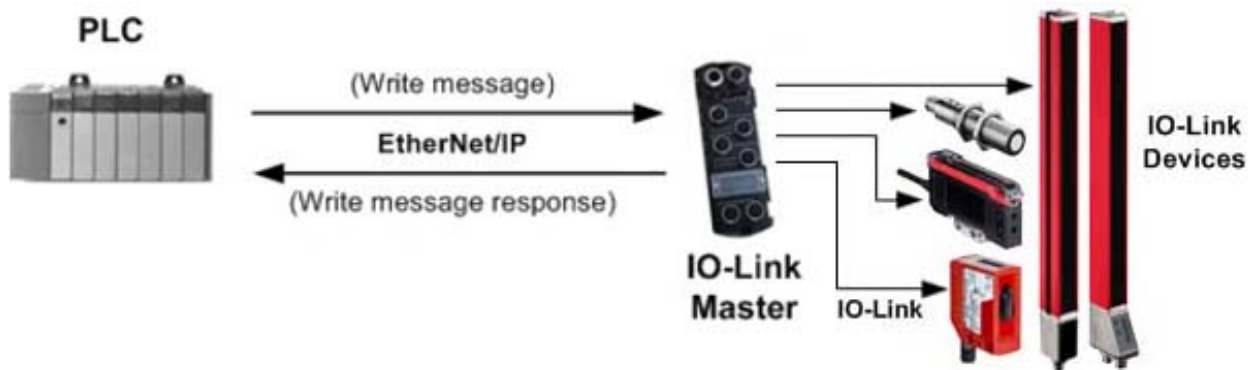

Figure 54: PLC-Writes Tx Transfer Method

12.2.2.2 Read-from-Tag/File-IO-Link Master Reads Data from PLC Memory

Also called *Master-Mode* for some industrial protocols, the Read-from-Tag/File method requires the IO-Link Master to read data from a tag or file on the PLC. In this method, the IO-Link Master requests data from the PLC at configurable time intervals.

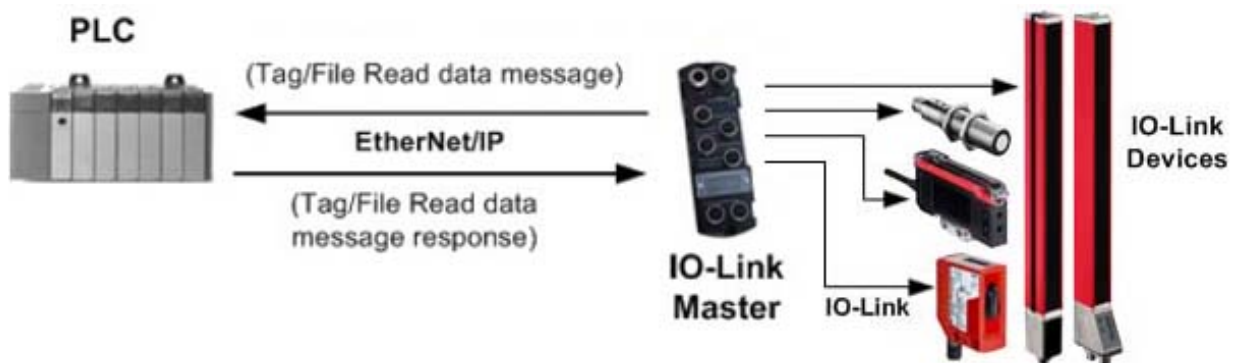

Figure 55: Read-from-Tag/File Tx Transfer Method

12.2.2.3 Class 1 Connection (Input and Output)-PLC and IO-Link Master Utilize an I/O Connection

Also called *I/O Mode* for some industrial protocols, the Class 1 connection method requires the IO-Link Master and PLC to connect to each via an I/O connection. For EtherNet/IP, a connection over UDP must first be created. Once the connection is established, the PLC and IO-Link Master continually exchange data at a configurable rate.

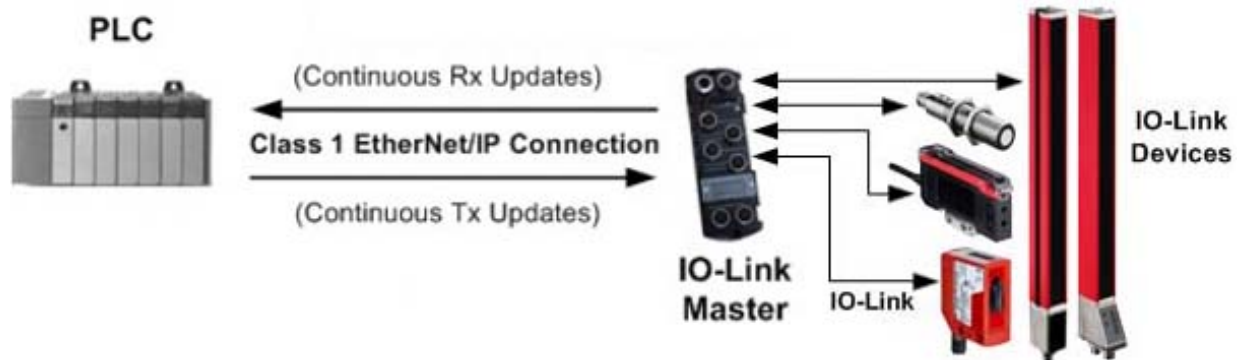

Figure 56: Class 1 Rx/Tx Transfer Method

13 EtherNet/IP CIP Object Definitions

The following are the vendor specific CIP Object definitions as supported in the IO-Link Master:

- *IO-Link Port Information Object Definition (71 hex), see Chapter 13.1*
- *PDI (Process Data Input) Transfer Object Definition (72 hex), see Chapter 13.2*
- *PDO (Process Data Output) Transfer Object Definition (73 hex), see Chapter 13.3*
- *ISDU Read/Write Object Definition (74 hex), see Chapter 13.4*

The following are standard CIP Object Definitions that are supported in the IO-Link Master.

- *Identity Object (01hex, 1 instance), see Chapter 13.5*
- *Message Router Object (02 hex), see Chapter 13.6*
- *Connection Manager Object (06 hex), see Chapter 13.7*
- *Port Object (F4 hex-1 instance), see Chapter 13.8*
- *TCP Object (F5 hex-1 instance), see Chapter 13.9*
- *Ethernet Link Object (F6 hex-1 instance), see Chapter 13.10*
- *PCCC Object (67 hex-1 instance), see Chapter 13.11*

13.1 IO-Link Port Information Object Definition (71 hex)

The IO-Link Device Information object defines the attributes by which the PLC can request standard device information stored in the IO-Link device’s ISDU blocks.

13.1.1 Class Attributes

The following table shows the class attributes for IO-Link port information object definition (71 hex).

Attribute ID	Name	Data Type	Data Value(s)	Access Rule
1	Revision	UINT	1	Get
2	Max Instance	UINT	4 (4-Port models) 8 (8-Port models)	Get
3	Num Instances	UINT	4 (4-Port models) 8 (8-Port models) <i>Note: Instance number determines the IO-Link port.</i>	Get

13.1.2 Instance Attributes

The following table shows the instance attributes for IO-Link port information object definition (71 hex).

Attribute ID	Name	Data Type	Data Value(s)	Access Rule
1	Vendor Name	Array of 64 SINTs	0-255	Get
2	Vendor Text	Array of 64 SINTs	0-255	Get
3	Product Name	Array of 64 SINTs	0-255	Get
4	Product Id	Array of 64 SINTs	0-255	Get
5	Product Text	Array of 64 SINTs	0-255	Get
6	Serial Number	Array of 16 SINTs	0-255	Get
7	Hardware Revision	Array of 64 SINTs	0-255	Get
8	Firmware Revision	Array of 64 SINTs	0-255	Get
9	Device PDI Length	INT	0-32	Get
10	Device PDO Length	INT	0-32	Get

Attribute ID	Name	Data Type	Data Value(s)	Access Rule
11	PDI Block Length	INT	4-36	Get
12	PDO Block Length	INT	0-36	Get
13	Input Assembly PDI Offset	INT	0-108 (8-bit format) 0-54 (16-bit format) 0-27 (32-bit format)	Get
14	Input Assembly PDO Offset	INT	16-246 (8-bit format) 8-123 (16-bit format) 4-62 (32-bit format)	Get
15	Output Assembly PDO Offset	INT	0-102 (8-bit format) 0-51 (16-bit format) 0-26 (32-bit format)	Get
16	Control Flags	INT	Bit settings	Get

13.1.3 Common Services

The following table shows the common services for IO-Link port information object definition (71 hex).

Service Code	Implemented in Class	Implemented in Instance	Service Name
01 hex	Yes	Yes	Get_Attributes_All
0E hex	Yes	Yes	Get_Attribute_Single

13.1.4 Instance Attribute Definitions

These attributes provide access to the standard ISDU information blocks on the IO-Link devices. These ISDUs are read at IO-Link device initialization time and then provided once the IO-Link device is operational.

13.1.4.1 Attribute 1-Vendor Name

Data	Attribute 1 - Vendor Name Description
64 ASCII characters	Requested from ISDU block index 16, contains the Vendor Name description of the IO-Link device.

13.1.4.2 Attribute 2-Vendor Text

Data	Attribute 2 - Vendor Text Description
64 ASCII characters	Requested from ISDU block index 17, contains the Vendor Text description of the IO-Link device.

13.1.4.3 Attribute 3-Product Name

Data	Attribute 3 - Product Name Description
64 ASCII characters	Requested from ISDU block index 18, contains the Product Name description of the IO-Link device.

13.1.4.4 Attribute 4-Product ID

Data	Attribute 4 - Product ID Description
64 ASCII characters	Requested from ISDU block index 19, contains the Product ID description of the IO-Link device.

13.1.4.5 Attribute 5-Product Text

Data	Attribute 5 - Product Text Description
64 ASCII characters	Requested from ISDU block index 20, contains the Product Text description of the IO-Link device.

13.1.4.6 Attribute 6-Serial Number

Data	Attribute 6 - Serial Number Description
16 ASCII characters	Requested from ISDU block index 21, contains the Vendor Specific Serial Number of the IO-Link device.

13.1.4.7 Attribute 7-Hardware Revision

Data	Attribute 7 - Hardware Revision Description
64 ASCII characters	Requested from ISDU block index 22, contains the Hardware Revision of the IO-Link device.

13.1.4.8 Attribute 8-Firmware Revision

Data	Attribute 8 - Firmware Revision Description
64 ASCII characters	Requested from ISDU block index 23, contains the Firmware Revision of the IO-Link device.

13.1.4.9 Attribute 9-Device PDI Length

Data	Attribute 9 - Device PDI Length Description
INT (0-32)	Requested from ISDU block index 0, sub-index 5. Contains the number of PDI data bytes provided by the IO-Link device.

13.1.4.10 Attribute 10-Device PDO Length

Data	Attribute 10 - Device PDO Length Description
INT	Requested from ISDU block index 0, sub-index 6. Contains the number of PDO data bytes required by the IO-Link device.

13.1.4.11 Attribute 11-PDI Data Block Length

Data	Attribute 11 - PDI Data Block Length Description
INT	The configured PDI block length in units based on the configurable PDI data format (8-bit, 16-bit, 32-bit). This contains the PDI block header, (port status, auxiliary bit, event code) status and the PDI data.

13.1.4.12 Attribute 12-PDO Data Block Length

Data	Attribute 12 - PDO Data Block Length Description
INT	The configured PDO data block length in units based on the configurable PDO data format (8-bit, 16-bit, 32-bit). Depending on the configuration, this may include both the returned event code and the PDO data.

13.1.4.13 Attribute 13-Input Assembly PDI Offset

Data	Attribute 13 - Input Assembly PDI Offset Description
INT	Based from the start of the first Input Assembly instance, the PDI data block's offset for the corresponding port's PDI data block. This index is based on the configurable PDI data format (8-bit, 16-bit, 32-bit). To use this offset effectively, it is recommended to set IO-Link Master PDI and PDO data as well as the Class 1 I/O connection all to the same data format.

13.1.4.14 Attribute 14-Input Assembly PDO Offset

Data	Attribute 14 - Input Assembly PDO Offset Description
INT	Based from the start of the first Input Assembly instance, the PDO data block's offset for the corresponding port's PDO data block. This index is based on the configurable PDO data format (8-bit, 16-bit, 32-bit). To use this offset effectively, it is recommended to set IO-Link Master PDI and PDO data as well as the Class 1 I/O connection all to the same data format.

13.1.4.15 Attribute 15-Output Assembly PDO Offset

Data	Attribute 15 - Output Assembly PDO Offset Description
INT	Based from the start of the first Output Assembly instance, the PDO data block's offset for the corresponding port's PDO data block. This index is based on the configurable PDO data format (8-bit, 16-bit, 32-bit). To use this offset effectively, it is recommended to set IO-Link Master PDI and PDO data as well as the Class 1 I/O connection all to the same data format.

13.1.4.16 Attribute 16-Control Flags

Data	Attribute 16 - Control Flags Description
INT (bit-mapped word)	<p>Bit 0 (01h): 1 = Indicates that the event code to clear is expected in the PDO block 0 = Indicates that the event code to clear is not expected in the PDO block.</p> <p>Bit 1 (02h): 1 = Indicates that the IO-Link device is SIO mode capable 0 = Indicates that the IO-Link device is not SIO mode capable</p> <p>Bits 2 (04h) 1 = Indicates that Class 1 Rx (receive PDI block) is enabled 0 = Indicates that Class 1 Rx (receive PDI block) is disabled</p> <p>Bit 3 (08h): 1 = Indicates that Class 1 Tx (transmit PDO) is enabled 0 = Indicates that Class 1 Tx (transmit PDO) is disabled</p> <p>Bit 4 (10h): 1 = Indicates that the digital output settings for DI and C/Q are expected in the PDO block 0 = Indicates that the digital output settings for DI and C/Q are not expected in the PDO block.</p> <p>Bit 5 -15: Reserved</p>

13.2 PDI (Process Data Input) Transfer Object Definition (72 hex)

The PDI Transfer object defines the attributes by which the PLC can request the PDI data block from the IO-Link Master.

13.2.1 Class Attributes

The following table displays Class Attributes for the PDI Transfer Object Definition (72 hex).

Attribute ID	Name	Data Type	Data Value(s)	Access Rule
1	Revision	UINT	1	Get
2	Max Instance	UINT	1	Get
3	Num Instances	UINT	1	Get

13.2.2 Instance Attributes

The following table displays Instance Attributes for the PDI Transfer Object Definition (72 hex).

Attribute ID	Name	Data Type	Length	Data Values	Access Rule
1	Port 1 PDI data block	Array of BYTEs	4-36 bytes	0-255	Get
2	Port 2 PDI data block	Array of BYTEs	4-36 bytes	0-255	Get
3	Port 3 PDI data block	Array of BYTEs	4-36 bytes	0-255	Get
4	Port 4 PDI data block	Array of BYTEs	4-36 bytes	0-255	Get
8-Port Models Only:					
5	Port 5 PDI data block	Array of BYTEs	4-36 bytes	0-255	Get
6	Port 6 PDI data block	Array of BYTEs	4-36 bytes	0-255	Get
7	Port 7 PDI data block	Array of BYTEs	4-36 bytes	0-255	Get
8	Port 8 PDI data block	Array of BYTEs	4-36 bytes	0-255	Get

13.2.3 Common Services

The following table shows Common Services for the PDI Transfer Object Definition (72 hex).

Service Code	Implemented in Class	Implemented in Instance	Service Name
01 hex	Yes	Yes	Get_Attributes_All
0E hex	Yes	Yes	Get_Attribute_Single

13.2.4 Instance Attribute Definitions - Attribute 1 to 4-PDI Data Blocks

These attributes provide access to the PDI data blocks.

- Get Attribute Single requests return the PDI data block for a specific port.
- Get Attribute All requests return all PDI data blocks from the IO-Link Master.

All PDI data is returned in the configured PDI format (8-bit, 16-bit or 32-bit). Refer to Chapter 13.2 PDI (Process Data Input) Transfer Object Definition (72 hex) for a detailed explanation of the PDI data block.

13.3 PDO (Process Data Output) Transfer Object Definition (73 hex)

The PDO Transfer object defines the attributes by which the PLC can:

- Request the PDO data block from the IO-Link Master.
- Write PDO data block to the IO-Link Master.

13.3.1 Class Attributes

The following table displays the Class Attributes for the PDO Transfer Object Definition (73 hex).

Attribute ID	Name	Data Type	Data Value	Access Rule
1	Revision	UINT	1	Get
2	Max Instance	UINT	1	Get
3	Num Instances	UINT	1	Get

13.3.2 Instance Attributes

The following table displays the Instance Attributes for the PDO Transfer Object Definition (73 hex).

Attribute ID	Name	Data Type	Length	Data Value	Access Rule
1	Port 1 PDO data block	Array of BYTEs	0-36 bytes	0-255	Get/Set
2	Port 2 PDO data block	Array of BYTEs	0-36 bytes	0-255	Get/Set
3	Port 3 PDO data block	Array of BYTEs	0-36 bytes	0-255	Get/Set
4	Port 4 PDO data block	Array of BYTEs	0-36 bytes	0-255	Get/Set
8-Port Models Only:					
5	Port 5 PDO data block	Array of BYTEs	0-36 bytes	0-255	Get/Set
6	Port 6 PDO data block	Array of BYTEs	0-36 bytes	0-255	Get/Set
7	Port 7 PDO data block	Array of BYTEs	0-36 bytes	0-255	Get/Set
8	Port 8 PDO data block	Array of BYTEs	0-36 bytes	0-255	Get/Set

13.3.3 Common Services

The following table displays the Common Services for the PDO Transfer Object Definition (73 hex).

Service Code	Implemented in Class	Implemented in Instance	Service Name
01 hex	Yes	Yes	Get_Attributes_All
0E hex	Yes	Yes	Get_Attribute_Single
10 hex	No	Yes	Set_Attribute_Single
02 hex	No	Yes	Set_Attribute_All

13.3.4 Instance Attribute Definitions - Attribute 1 to 4-PDO Data Blocks

These attributes provide write access to the PDO data blocks.

- Get Attribute Single requests return the current PDO data block for a specific port.
- Get Attribute All requests return all current PDO data blocks from the IO-Link Master.
- Set Attribute Single allows writing the PDO data to one IO-Link port on the IO-Link Master.
- Set Attribute All messages allow writing of PDO data to all IO-Link ports on the IO-Link Master.

All PDO data is received and returned in the configured PDO format (8-bit, 16-bit or 32-bit). Refer to Chapter 13.3 PDO (Process Data Output) Transfer Object Definition (73 hex) for a detailed explanation of the PDO data block.

13.4 ISDU Read/Write Object Definition (74 hex)

The ISDU Read/Write object defines the attributes by which the PLC can:

- Send an ISDU request containing one or more read and/or write ISDU commands to an IO-Link device via the IO-Link Master.
- Request the ISDU response(s) from the IO-Link Master.
- Send both blocking and non-blocking ISDU requests.

Refer to the ISDU Handling chapter for a detailed description of the ISDU functionality.

13.4.1 Class Attributes

The following table shows the Class Attributes for the ISDU Read/Write Object Definition (74 hex).

Attribute ID	Name	Data Type	Data Value(s)	Access Rule
1	Revision	UINT	1	Get
2	Max Instance	UINT	4 (4-Port Models) 8 (8-Port Models)	Get
3	Num Instances	UINT	4 (4-Port Models) 8 (8-Port Models) <i>Note: Instance number determines IO-Link port on the IO-Link Master.</i>	Get

13.4.2 Instance Attributes

The following table shows the Instance Attributes for the ISDU Read/Write Object Definition (74 hex).

Attribute ID	Name	Data Type	Data Value(s)	Access Rule
1	ISDU Response	ISDU response data block	0-255	Get
2	ISDU Read/Write Request	ISDU request data block	0-255	Set

13.4.3 Common Services

The following table shows the Common Services for the ISDU Read/Write Object Definition (74 hex).

Service Code	Implemented in Class	Implemented in Instance	Service Name
01 hex	Yes	No	Get_Attributes_All
0E hex	Yes	Yes	Get_Attribute_Single
10 hex	No	Yes	Set_Attribute_Single
02 hex	No	No	Set_Attribute_All

13.4.4 Object Specific Services

The following table shows the Object Specific Services for the ISDU Read/Write Object Definition (74 hex).

Service Code	Implemented in Class	Implemented in Instance	Service Name
4B hex	No	Yes	Blocking ISDU Request

The Blocking ISDU Request service allows one message instruction to both send an ISDU request and receive the response. Using this service causes the message to be active for several seconds.

13.4.5 Instance Attribute Definitions

The following attributes provide access to the ISDU blocks on the IO-Link devices.

13.4.5.1 Attribute 1-ISDU Read/Write Response (Non-Blocking only)

Get Attribute Single messages returns the ISDU response for a specific port through the IO-Link Master. The response may need to be read multiple times until a response of Success, Failure, or Timed Out has been received.

13.4.5.2 Attribute 2-ISDU Read/Write Request (Non-blocking only)

Set Attribute Single messages can send read/write type ISDU requests to the IO-Link devices via the IO-Link Master. The ISDU request message need be sent only once for each ISDU read/write request.

13.5 Identity Object (01hex, 1 instance)

The Identity Object provides identification of and general information about the IO-Link Master.

13.5.1 Class Attributes

This table shows the Class Attributes for the Identity Object (01 hex, 1 Instance).

Attribute ID	Name	Data Type	Data Value(s)	Access Rule
1	Revision	UINT	1	Get
2	Max Class	UINT	1	Get
3	Max Instance	UINT	1	Get
6	Maximum Number Class Attribute	UINT	7	Get
7	Maximum Number Instance Attributes	UINT	7	Get

13.5.2 Instance Attributes

This table shows the Instance Attributes for the Identity Object (01 hex, 1 Instance).

Attribute ID	Name	Data Type	Data Value(s)	Access Rule
1	Vendor ID	UINT	909 (Leuze electronic)	Get
2	Device Type	UINT	2B hex (Generic Device)	Get
3	Product Code	UINT	As defined by Leuze electronic	Get

Attribute ID	Name	Data Type	Data Value(s)	Access Rule
4	Revision (Product or Software release) <i>Structure of:</i> Major Revision Minor Revision	USINT USINT	1 to 127 1 to 255	Get
5	Status	WORD	See Below	Get
6	Serial Number	UDINT	1-FFFFFFFF hex	Get
7	Product Name <i>Structure of:</i> Name Length Name String	USINT STRING	Length of string See below	Get Get

13.5.3 Status Word

Refer to Page 52 of Volume 3.5 of the CIP Common Specification.

The following applies to the Identity Object status word for the IO-Link Master.

Status Word Bit	Setting	Description
0	0	Ownership Flag. Does not apply to the IO-Link Master.
1	0	Reserved.
2	0	IO-Link Master is operating on the default configuration.
	1	The IO-Link Master has a configuration other than the default configuration.
3	0	Reserved.
4-7	0101 (0x50)	Indicates that there is a major fault (either Bit 10 or Bit 11 is set).
	0100 (0x40)	Indicates the stored configuration is invalid.
	0011 (0x30)	Indicates the system is operational and there are no I/O (Class 1) connections.
	0110 (0x60)	Indicates the system is operational and there is at least one active I/O (Class 1) connection.
	0000	Indicates the system is not operational. It may be in any of the following states: <ul style="list-style-type: none"> System startup. Configuration in process. Idle. Critical (major) fault.
8	0	No recoverable minor fault. No error history entry reported within the last ten seconds.
	1	Recoverable minor fault. The IO-Link Master has reported an error within the last ten seconds and a major fault has not been detected.
9	1	Unrecoverable minor fault. Does not apply to the IO-Link Master.
10	0	No recoverable major fault.
	1	A major recoverable fault exists. This is a fault that the IO-Link Master may be able to recover from by a system reset. If the system does not recover automatically, a system reset message or a power cycle of the IO-Link Master may be required.
11	0	No major unrecoverable fault.
	1	A major unrecoverable fault has occurred in the IO-Link Master. If the major fault is not corrected with a system reset or a power cycle, refer to the User Guide or call Leuze electronic support.
12-15	0	Reserved.

13.5.4 Common Services

Service Code	Implemented in Class	Implemented in Instance	Service Name
01 hex	Yes	Yes	Get_Attribute_All
05 hex	No	Yes	Reset
0E hex	Yes	Yes	Get_Attribute_Single

13.6 Message Router Object (02 hex)

The Message Router Object provides a messaging connection point through which a Client may address a service to any object or instance residing in the physical device.

13.6.1 Class Attributes

This table displays the Class Attributes for the Message Router Object (02 hex).

Attribute ID	Name	Data Type	Data Value	Access Rule
1	Revision	UINT	1	Get
2	Max Class	UINT	1	Get
3	Max Instance	UINT	1	Get
4	Optional Attribute List	UINT	2	Get
5	Option Service List	UINT	1	Get
6	Maximum Number Class Attribute	UINT	7	Get
7	Maximum Number Instance Attribute	UINT	2	Get

13.6.2 Instance Attributes

This table displays the Instance Attributes for the Message Router Object (02 hex)

Attribute ID	Name	Data Type	Data Value(s)	Access Rule
1	Object List <i>Structure of:</i> Number	UINT	Number of supported standard class codes	Get
	Classes	Array of UINT	List of supported standard class codes	Get
2	Max Connections	UINT	128	Get

13.6.3 Common Services

This table displays the Common Services for the Message Router Object (02 hex)

Service Code	Implemented in Class	Implemented in Instance	Service Name
01 hex	Yes	No	Get_Attribute_All
0E hex	Yes	Yes	Get_Attribute_Single
0A hex	No	Yes	Multiple_Service_Req

13.7 Connection Manager Object (06 hex)

This object provides services for connection and connection-less communications. This object has no supported attributes.

13.7.1 Class Attributes Object (06 hex)

The following table displays the Class Attributes for the Connection Manager Object (06 hex).

Attribute ID	Name	Data Type	Data Value(s)	Access Rule
1	Revision	UINT	1	Get
2	Max Class	UINT	1	Get
3	Max Instance	UINT	1	Get
4	Optional Attribute List	UINT	8	Get
6	Maximum number Class Attribute	UINT	7	Get
7	Maximum Number Instance Attributes	UINT	8	Get

13.7.2 Instance Attributes (02 hex)

This table displays the Instance Attributes for the Message Router Object (02 hex).

Attribute ID	Name	Data Type	Data Value(s)	Access Rule
1	Open Requests	UINT	0-0xffffffff	Set/Get
2	Open Format Rejects	UINT	0-0xffffffff	Set/Get
3	Open Resource Rejects	UINT	0-0xffffffff	Set/Get
4	Open Other Rejects	UINT	0-0xffffffff	Set/Get
5	Close Requests	UINT	0-0xffffffff	Set/Get
6	Close Format Requests	UINT	0-0xffffffff	Set/Get
7	Close Other Requests	UINT	0-0xffffffff	Set/Get
8	Connection Time Outs	UINT	0-0xffffffff	Set/Get

13.7.3 Common Services Object (06 hex)

This table displays the Common Services for the Connection Manager Object (06 hex).

Service Code	Implemented in Class	Implemented in Instance	Service Name
01 hex	Yes	Yes	Get_Attribute_All
02 hex	No	Yes	Set_Attribute_ALL
0E hex	Yes	Yes	Get_Attribute_Single
10 hex	No	Yes	Set_Attribute_Single
4E hex	N/A	N/A	Forward_Close
52 hex	N/A	N/A	Unconnected_Send
54 hex	N/A	N/A	Forward_Open
5A hex	N/A	N/A	Get_Connection_Owner
5B hex	N/A	N/A	Large_Forward_Open

13.8 Port Object (F4 hex-1 instance)

The Port Object enumerates the CIP ports present on the IO-Link Master.

13.8.1 Class Attributes

This table illustrates the Class Attributes for the Port Object (F4 hex - 1 Instance)

Attribute ID	Name	Data Type	Data Value(s)	Access Rule
1	Revision	UINT	1	Get
2	Max Instance	UINT	1	Get
3	Num Instances	UINT	1	Get
6	Maximum Number Class Attributes	UINT	9	Get
7	Maximum Number Instance Attributes	UINT	7	Get
8	Entry Port	UINT	1	Get
9	All Ports	Array of UINT	[0]=0 [1]=0 [2] = 1 (Vendor Specific) [3] = 1 (Backplane) [4]=TCP_IP_PORT_TYPE (4) [5]=TCP_IP_PORT_NUMBER(2)	Get

13.8.2 Instance Attributes

This table illustrates the Instance Attributes for the Port Object (F4 hex - 1 Instance).

Attribute ID	Name	Data Type	Data Value(s)	Access Rule
1	Port Type	UINT	1	Get
2	Port Number	UINT	1	Get
3	Port Object <i>Structure of:</i> 16 bit word count in path Path	UINT Array of UINT	2 [0]=6420 hex [1]=0124 hex	Get Get
4	Port Name <i>Structure of:</i> String Length Port Name	USINT Array of USINT	10 "Backplane"	Get Get
7	Node Address	USINT[2]	0x10, 0x00	Get

This table illustrates the Instance Attributes for the Port Object (F4 hex - 2 Instance).

Attribute ID	Name	Data Type	Data Value(s)	Access Rule
1	Port Type	UINT	4 (TCP/IP)	Get
2	Port Number	UINT	2 (TCP/IP)	Get
3	Port Object Structure of: 16 bit word count in path Path	UINT Array of UINT	2 [0]=F520 hex [1]=0124 hex	Get Get
4	Port Name <i>Structure of:</i> String Length Port Name	USINT Array of USINT	17 "Ethernet/IP Port"	Get Get
7	Node Address	USINT[2]	0x10, 0x00	Get

13.8.3 Common Services

This table illustrates the Common Services for the Port Object (F4 hex - 1 Instance).

Service Code	Implemented in Class	Implemented in Instance	Service Name
01 hex	Yes	Yes	Get_Attribute_All
0E hex	Yes	Yes	Get_Attribute_Single

13.9 TCP Object (F5 hex-1 instance)

The TCP/IP Interface Object provides the mechanism to retrieve the TCP/IP attributes for the IO-Link Master.

13.9.1 Class Attributes

This table shows the Class Attributes for the TCP Object (F5 hex - 1 Instance).

Attribute ID	Name	Data Type	Data Value	Access Rule
1	Revision	UINT	1	Get
2	Max Instance	UINT	1	Get
3	Num Instances	UINT	1	Get
4	Optional Attribute List	UINT	4	Get
6	Maximum Number Class Attribute	UINT	7	Get
7	Maximum Number Instance Attribute	UINT	9	Get

13.9.2 Instance Attributes

This table shows the Instance Attributes for the TCP Object (F5 hex - I Instance).

Attribute ID	Name	Data Type	Data Value(s)	Access Rule
1	Status	DWORD	0 = The Interface Configuration attribute has not been configured. 1 = The Interface Configuration attribute contains configuration obtained from DHCP or nonvolatile storage. 2 = The IP address member of the Interface Configuration attribute contains configuration obtained, in part, from the hardware rotary switch settings. <ul style="list-style-type: none"> • Upper 3 bytes from nonvolatile storage. • Least significant byte from rotary switches. 	Get
2	Configuration Capability	DWORD	34 hex (DHCP, Settable and Hardware) 04 hex = DHCP 10 hex = Settable 20 hex = Hardware configurable	Get
3	Configuration Control	DWORD	Interface control Flags: 0 = The device shall use statically-assigned IP configuration values. 2 = The device shall obtain its interface configuration values via DHCP.	Set/Get
4	Physical Link Object <i>Structure of:</i> Path Size Path	UINT Array of USINT	2 [0]=20 hex [1]=F6 hex [2]=24 hex [3]=01 hex	Get
5	Interface Configuration <i>Structure of:</i> IP Address Network Mask Gateway Address Name Server Name Server 2 Domain Name Length Domain Name	UDINT UDINT UDINT UDINT UDINT UINT STRING	<IP address> <Network mask> <Gateway Address> <Name server> <Name server2> <Length of name> <Domain name>	Set/Get

Attribute ID	Name	Data Type	Data Value(s)	Access Rule
6	Host Name Structure of: Host Name Length Host Name String	UINT STRING	0 to 15 <Default =IP NULL (0)>	Set/Get
8	TTL (Time-to-Live) value for IP multicast packets.	USINT	1 to 255 <Default = 1>	Set/Get
9	IP Multicast Address Configuration	<i>Struct of:</i> USINT - Alloc Control USINT - Reserved UINT - Num Mcast UDINT - Start Mcast Address	Alloc Control: 0 = Default Algorithm 1 = Configuration Num Mcast: 1 to 32 Start Mcast Address: 239.192.1.0 to 239.255.255.255	Set/Get

13.9.3 Common Services

This table shows the Common Services for the TCP Object (F5 hex - I Instance).

Service Code	Implemented in Class	Implemented in Instance	Service Name
01 hex	Yes	Yes	Get_Attribute_All
02 hex	No	Yes	Set_Attribute_All
0E hex	Yes	Yes	Get_Attribute_Single
10 hex	No	Yes	Set_Attribute_Single

13.10 Ethernet Link Object (F6 hex-1 instance)

The Ethernet Link Object maintains link-specific counters and status information for the Ethernet communications interface on the IO-Link Master.

13.10.1 Class Attributes

This table displays the Class Attributes for the Ethernet Link Object (F6 hex - 1 Instance).

Attribute ID	Name	Data Type	Data Value(s)	Access Rule
1	Revision	UINT	3	Get
2	Max Instance	UINT	1	Get
3	Num Instances	UINT	1	Get
4	Optional Attribute List	UINT	4	Get
6	Maximum Number Class Attributes	UINT	7	Get
7	Maximum Number Instance Attributes	UINT	1	Get

13.10.2 Instance Attributes

This table displays the Instance Attributes for the Ethernet Link Object (F6 hex - 1 Instance).

Attribute ID	Name	Data Type	Data Value(s)	Access Rule
1	Interface speed (Current operational speed)	UDINT	10=10 Mbit 100=100 Mbit	Get
2	Interface Flags (Current operational status)	DWORD	Bit 0 =link status (0=inactive) (1=active) Bit 1=Half/Full Duplex (0=half duplex) (2=full duplex) Bits 2-4: 00 = negotiation in progress 01 = negotiation failed 02 = negotiation failed speed OK 03 = negotiation success	Get
3	Physical Address	Array of 6 USINT	MAC Address	Get
7	Interface Type	USINT	2 = Twisted Pair	Get
8	Interface State	USINT	1 = Interface is enabled and operational	Get
9	Admin State	USINT	1 = Interface enabled	Get
10	Interface Label	USINT16 Array of USINT	Length = 1 to 64 ASCII characters <Default = IP address in "xxx.xxx.xxx.xxx" format>	Get

13.10.3 Services

This table displays the Common Services for the Ethernet Link Object (F6 hex - 1 Instance)

Service Code	Implemented in Class	Implemented in Instance	Service Name
01 hex	Yes	Yes	Get_Attribute_All
0E hex	Yes	Yes	Get_Attribute_Single

13.11 PCCC Object (67 hex-1 instance)

The PCCC Object provides the ability to encapsulate and then transmit and receive PCCC messages between devices on an Ethernet/IP network. This object is used to communicate to MicroLogix, SLC 5/05 and PLC-5 PLCs over EtherNet/IP.

The PCCC Object does not support the following:

- Class Attributes
- Instance Attributes

13.11.1 Instances

The PCCC Object supports Instance 1.

13.11.2 Common Services

The following table displays the Common Services for the PCCC Object.

Service Code	Implemented in Class	Implemented in Instance	Service Name
4B hex	No	Yes	Execute_PCCC

13.11.3 Message Structure Execute_PCCC: Request Message

This table displays the message structure for the Execute_PCCC Request Message for the PCCC Object.

Name	Data Type	Description
Length	USINT	Length of requestor ID
Vendor	UINT	Vendor number of requestor
Serial Number	UDINT	ASA Serial number of requestor
CMD	USINT	Command byte
STS	USINT	0
TNSW	UINT	Transport word
FNC	USINT	Function Code.
PCCC_params	Array of USINT	CMD/FMC specific parameters

13.11.4 Message Structure Execute_PCCC: Response Message

This table displays the message structure for the Execute PCCC Response Message for the PCCC Object.

Name	Data Type	Description
Length	USINT	Length of requestor ID
Vendor	UINT	Vendor number of requestor
Serial Number	UDINT	ASA Serial number of requestor
CMD	USINT	Command byte
STS	USINT	Status Byte
TNSW	UINT	Transport word. Same value as request.
EXT_STS	USINT	Extended status. (If error)
PCCC_params	Array of USINT	CMD/FMC specific result data

13.11.5 Supported PCCC Command Types

The following table displays the Supported PCCC Command Types for the PCCC Object.

CMD	FNC	Description
0F hex	A2 hex	SLC 500 protected typed read with 3 address fields
0F hex	AA hex	SLC 500 protected typed write with 3 address fields

13.12 Assembly Object (For Class 1 Interface)

The EtherNet/IP specification requires that all Class 1 interfaces be provided through the Assembly Object interface. The Assembly Object interface is used to directly tie Vendor Specific objects to a standard interface, which the EtherNet/IP controller, or PLC, uses to communicate to the device.

For the IO-Link Master, the Assembly Object corresponds to the PDI and PDO Transfer objects. Each instance of the Assembly Object corresponds to one or more of the PDI and/or PDO Transfer Object attributes.

The Assembly Object is linked to the Process IO vendor specific object, which provides access to the PDI and PDO data. The Assembly object defines the interface by which a Class 1 PLC or controller can:

- Request the PDI data block from the IO-Link Master.
- Write the PDO data block to the IO-Link Master.

13.12.1 Class Attributes

This table shows the Class Attributes for the Assembly Object for a Class 1 interface.

Attribute ID	Name	Data Type	Data Value(s)	Access Rule
1	Revision	UINT	1	Get
2	Max Instance	UINT	12 (4-Port Models) 24 (8-Port Models)	Get
3	Num Instances	UINT	12 (4-Port Models) 24 (8-Port Models)	Get

13.12.2 Instance Definitions (4-Port Models)

This table shows the Instance Definitions for the Assembly Object for a Class 1 interface for the 4-port models.

Assembly Instance Number	Description	Data Type	Data Values	Access Rule
101	PDI data blocks from Ports 1 to 4. PDO data blocks from ports 1-4	BYTE Array Valid read lengths: 1-288	0-255	Get
102	PDI data blocks from Ports 2 to 4. PDO data blocks from Ports 1-4	BYTE Array Valid read lengths: 1-252	0-255	Get
103	PDI data blocks from Ports 3 to 4. PDO data blocks from Ports 1-4	BYTE Array Valid read lengths: 1-216	0-255	Get

Assembly Instance Number	Description	Data Type	Data Values	Access Rule
104	PDI data blocks from Port 4. PDO data blocks from Ports 1-4	BYTE Array Valid read lengths: 1-180	0-255	Get
105	PDO data blocks from Ports 1-4	BYTE Array Valid read lengths: 0-144	0-255	Get
106	PDO data blocks from Ports 2-4	BYTE Array Valid read lengths: 0-108	0-255	Get
107	PDO data blocks from Ports 3-4	BYTE Array Valid read lengths: 0-72	0-255	Get
108	PDO data blocks from Port 4	BYTE Array Valid read lengths: 0-36	0-255	Get
109	PDO data blocks to Ports 1-4	BYTE Array Valid read lengths: 0-144	0-255	Set
110	PDO data blocks to Ports 2-4	BYTE Array Valid read lengths: 0-108	0-255	Set
111	PDO data blocks to Ports 3-4	BYTE Array Valid read lengths: 0-72	0-255	Set
112	PDO data blocks to Port 4	BYTE Array Valid read lengths: 0-36	0-255	Set

13.12.3 Instance Definitions (8-Port Models)

This table shows the Instance Definitions for the Assembly Object for a Class 1 interface for the 8-port models.

Assembly Instance Number	Description	Data Type	Data Values	Access Rule
101	PDI data blocks from Ports 1 to 8. PDO data blocks from ports 1-8	BYTE ArrayValid read lengths: 1-576	0-255	Get
102	PDI data blocks from Ports 2 to 8. PDO data blocks from Ports 1-8	BYTE ArrayValid read lengths: 1-540	0-255	Get
103	PDI data blocks from Ports 3 to 8. PDO data blocks from Ports 1-8	BYTE Array Valid read lengths: 1-504	0-255	Get
104	PDI data blocks from Port 4-8. PDO data blocks from Ports 1-8	BYTE Array Valid read lengths: 1-468	0-255	Get
105	PDI data blocks from Ports 5-8 PDO data blocks from Ports 1-8	BYTE Array Valid read lengths: 0-432	0-255	Get
106	PDI data blocks from Ports 6 to 8. PDO data blocks from Ports 1-8	BYTE Array Valid read lengths: 0-396	0-255	Get
107	PDI data blocks from Ports 7 to 8. PDO data blocks from Ports 1-8	BYTE Array Valid read lengths: 0-360	0-255	Get
108	PDI data blocks from Port 8. PDO data blocks from Ports 1-8	BYTE Array Valid read lengths: 0-324	0-255	Get
109	PDO data blocks from Ports 1-8	BYTE Array Valid read lengths: 0-288	0-255	Get
110	PDO data blocks from Ports 2-8	BYTE Array Valid read lengths: 0-252	0-255	Get
111	PDO data blocks from Ports 3-8	BYTE Array Valid read lengths: 0-216	0-255	Get
112	PDO data blocks from Port 4-8	BYTE Array Valid read lengths: 0-180	0-255	Get
113	PDO data blocks from Ports 5-8	BYTE Array Valid read lengths: 0-144	0-255	Get
114	PDO data blocks from Ports 6-8	BYTE Array Valid read lengths: 0-108	0-255	Get
115	PDO data blocks from Ports 7-8	BYTE Array Valid read lengths: 0-72	0-255	Get

Assembly Instance Number	Description	Data Type	Data Values	Access Rule
116	PDO data blocks from Port 8	BYTE Array Valid read lengths: 0-36	0-255	Get
117	PDO data blocks to Ports 1-8	BYTE Array Valid read lengths: 0-288	0-255	Set
118	PDO data blocks to Ports 2-8	BYTE Array Valid read lengths: 0-252	0-255	Set
119	PDO data blocks to Ports 3-8	BYTE Array Valid read lengths: 0-216	0-255	Set
120	PDO data blocks to Ports 4-8	BYTE Array Valid read lengths: 0-180	0-255	Set
121	PDO data blocks to Ports 5-8	BYTE Array Valid read lengths: 0-144	0-255	Set
122	PDO data blocks to Ports 6-8	BYTE Array Valid read lengths: 0-108	0-255	Set
123	PDO data blocks to Ports 7-8	BYTE Array Valid read lengths: 0-72	0-255	Set
124	PDO data blocks to Port 8	BYTE Array Valid read lengths: 0-36	0-255	Set

13.12.4 Instance Attributes

This table shows the Instance Attributes for the Assembly Object for a Class 1 interface.

Attribute ID	Name	Data Type	Data Value(s)	Access Rule
3	Data	Array of BYTE	0-255	Get/Set
4	Data Length	UINT	Maximum number of bytes in attribute 3	Get

13.12.5 Common Services

This table shows the Common Services for the Assembly Object for a Class 1 interface.

Service Code	Implemented in Class	Implemented in Instance	Service Name
01 hex	Yes	No	Get_Attributes_All
0E hex	Yes	Yes	Get_Attribute_Single
10 hex	No	Yes	Set_Attribute_Single
02 hex	No	No	Set_Attribute_All

13.12.6 Instance Attribute Definitions: Attribute 3-Request/Write Data

Dependent on the instance number, this is either the PDI data block and/or the PDO data block.

13.12.7 Instance Attribute Definitions: Attribute 4-Data Length

This is the maximum data length for each Assembly instance.

13.12.8 Overview of Assembly Interface

The Assembly interface is designed to:

- Provide access to all Input and Output assemblies.
- Maximize flexibility for the PLC programmer.
- Minimize required PLC and IO-Link communication bandwidth.
- Be as easy to use as possible.

The following diagram illustrates the Assembly instances for a four port IO-Link Master. There is one Assembly input and output instance assigned to each IO-Link port.

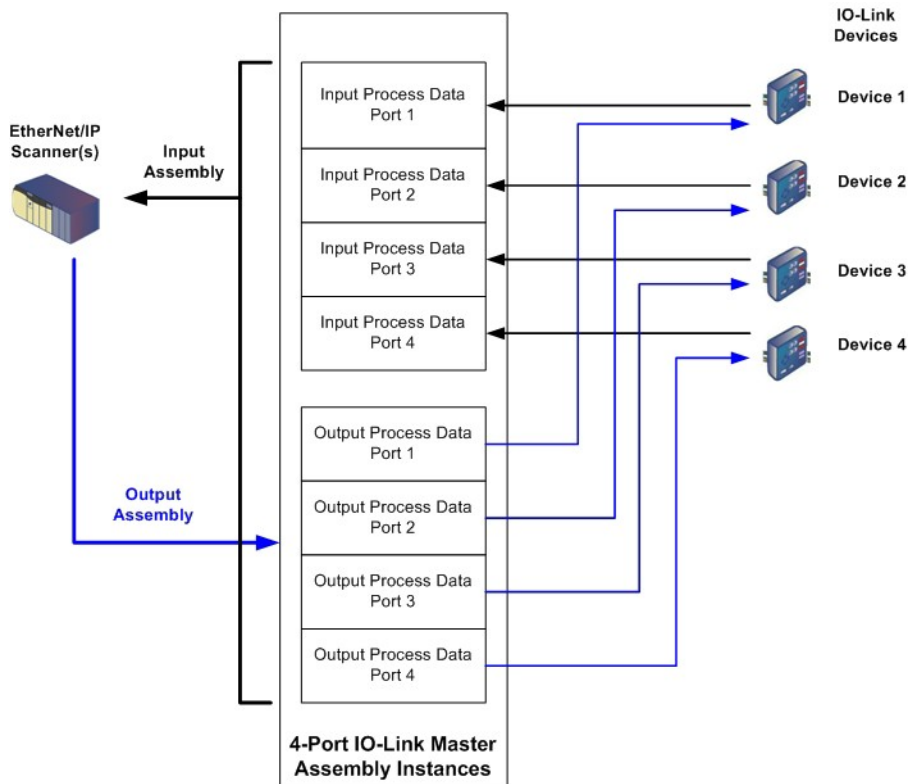

Figure 57: Overview of Assembly Interface, 4-Port IO-Link Master Assembly Instances

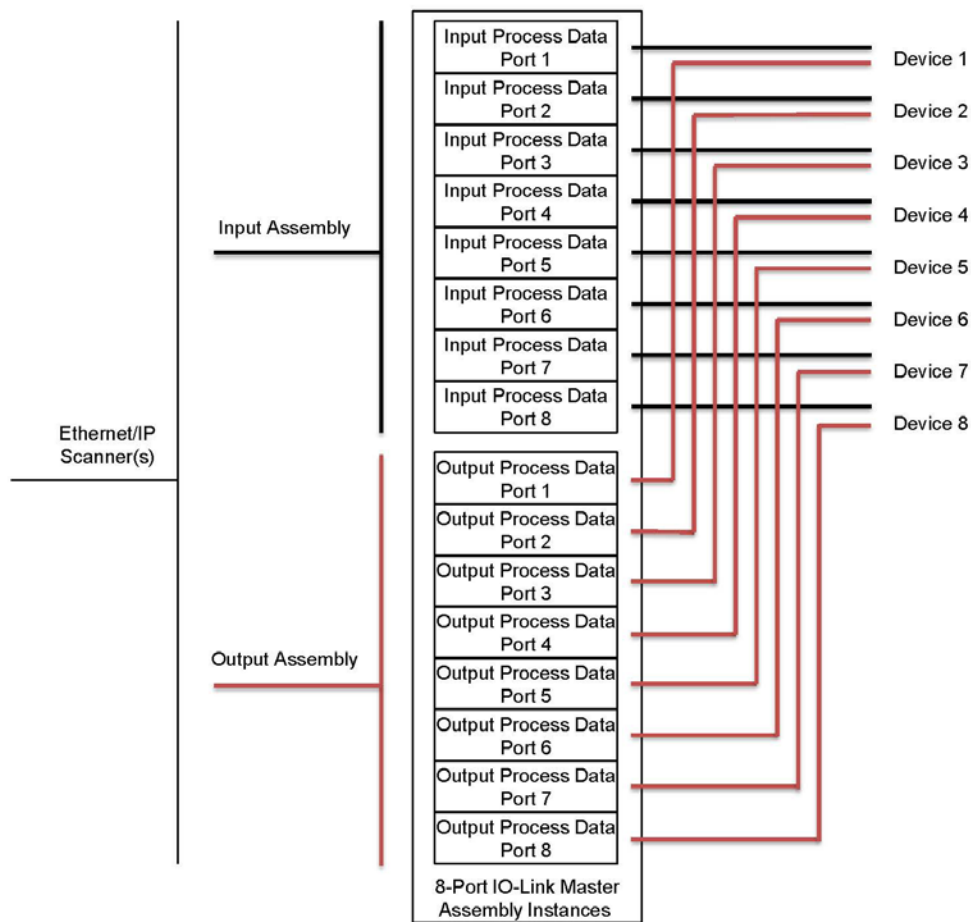

Figure 58: Overview of Assembly Interface, 8-Port IO-Link Master Assembly Instances

13.12.9 Grouping of Assembly Instances

In order to minimize the number of required I/O connections, the input and output assembly instances are organized as follows. The Input Assembly instances are grouped into one continuous array with no gaps between the instances. The same is also true for Output Assembly Instances.

13.12.9.14-Port Models

Assembly Controller Access									
	Assembly Instance Number	Controller Port 1 Access		Controller Port 2 Access		Controller Port 3 Access		Controller Port 4 Access	
		Read (Input)	Write (Output)	Read (Input)	Write (Output)	Read (Input)	Write (Output)	Read (Input)	Write (Output)
Read (Input) Process Data Input	101 (Port 1)								
	102 (Port 2)								
	103 (Port 3)								
	104 (Port 4)								

Assembly Controller Access									
	Assembly Instance Number	Controller Port 1 Access		Controller Port 2 Access		Controller Port 3 Access		Controller Port 4 Access	
		Read (Input)	Write (Output)	Read (Input)	Write (Output)	Read (Input)	Write (Output)	Read (Input)	Write (Output)
Read (Input) Process Data Output	105 (Port 1)								
	106 (Port 2)								
	107 (Port 3)								
	108 (Port 4)								
Write (Output) Process Data Output	109 (Port 1)								
	110 (Port 2)								
	111 (Port 3)								
	112 (Port 4)								

Where:

- All accessible data can be read (input) and written (output) from one I/O connection.
- Controller Read (Input) access:
 - One or more input instances may be read with one I/O connection. (i.e. If addressing the instance 101, all input instances for both PDI and PDO data, 101 to 108 (for 4-port models), may be read in one connection.)
 - The length of the Read (Input) connection can range from 1 to the total length for all input instances.
 - Multiple controllers can read access to the Input Assembly instances at one time.
- Controller Write (Output) access:
 - Only output instances may be written.
 - One or more output instances may be written to with one connection.
 - The length of the Write (Output) connection must be equal to the total length of the output instance(s).
 - Only one controller may have write access to an output instance.

Note: In order to receive all PDI and PDO data in one Class 1 connection, it may be necessary to decrease the size of one or more PDI and/or PDO blocks via the embedded EtherNet/IP configuration web page.

13.12.9.28-Port Models

Assembly Controller Access									
	Assembly Instance Number	Controller Port 1 Access		Controller Port 2 Access		Controller Port 3 Access		Controller Port 8 Access	
		Read (Input)	Write (Output)	Read (Input)	Write (Output)	Read (Input)	Write (Output)	Read (Input)	Write (Output)
Read (Input) Process Data Input	101 (Port 1)								
	102 (Port 2)								
	103 (Port 3)								
	104 (Port 4)								
	105 (Port 5)								
	106 (Port 6)								
	107 (Port 7)								
	108 (Port 8)								
Read (Input) Process Data Output	109 (Port 1)								
	110 (Port 2)								
	111 (Port 3)								
	112 (Port 4)								
	113 (Port 5)								
	114 (Port 6)								
	115 (Port 7)								
	116 (Port 8)								
Write (Output) Process Data Output	117 (Port 1)								
	118 (Port 2)								
	119 (Port 3)								
	120 (Port 4)								
	121 (Port 5)								
	122 (Port 6)								
	123 (Port 7)								
	124 (Port 8)								

Where:

- All accessible data can be read (input) and written (output) from one I/O connection.
- Controller Read (Input) access:
 - One or more input instances may be read with one I/O connection. (i.e. If addressing the instance 101, all input instances for both PDI and PDO data, 101 to 116 (for 8-port models), may be read in one connection.)
 - The length of the Read (Input) connection can range from 1 to the total length for all input instances.
 - Multiple controllers can read access to the Input Assembly instances at one time.
- Controller Write (Output) access:
 - Only output instances may be written.
 - One or more output instances may be written to with one connection.
 - The length of the Write (Output) connection must be equal to the total length of the output instance(s).
 - Only one controller may have write access to an output instance.

Note: *In order to receive all PDI and PDO data in one Class 1 connection, it may be necessary to decrease the size of one or more PDI and/or PDO blocks via the embedded EtherNet/IP configuration web page.*

14 SLC/PLC-5/MicroLogix Interface

The IO-Link Master provides support for the SLC, PLC-5 and MicroLogix PLCs. The following features are supported:

- Rx PDI data, both Polling and Write-to-File modes.
- Tx PDO data, both PLC-Writes and Read-From-File modes.
- PCCC based messages transferred by means of the PCCC CIP object, including:
 - SLC Typed Read Message
 - SLC Typed Write Message
 - PLC-5 Typed Read Message (Logical ASCII address format)
 - PLC-5 Typed Write Message (Logical ASCII address format)
- Receive, transmit and statistics data.
- Standard PLC-5/SLC file naming conventions.
- Controlled message rate to the PLC when operating in the Write-to-File receive method. This is accomplished by setting the **Maximum PLC Update Rate**.

The primary differences between the PLC-5/SLC interface and the ControlLogix interfaces are:

- Since the PLC-5 and SLC PLCs operate on a file memory system, the PLC-5/SLC interface provides Write-to-File and Read-from-File communication methods in place of Write-to-Tag and Read-from-Tag communication methods. The Write-to-File methods operate in a very similar manner to the Write-to-Tag method available for the ControlLogix family of PLCs.
- Polling is performed through the PLC-5/SLC specific messages instead of accessing the Serial Port Data Transfer object.
- When configuring the IO-Link Master to operate in Write-to-File or Read-from-File, enter the file name starting with an **N** (i.e. N10:0).

Note: While ControlLogix PLCs support the SLC and PLC-5 messages, using those messages on ControlLogix PLCs is not recommended due to data size and performance considerations.

14.1 Requirements

Your PLC-5/SLC/MicroLogix PLC must support:

- MultiHop
- ControlLogix devices
- EtherNet/IP

The following tables list PLCs that support EtherNet/IP and the required firmware version for each PLC.

Note: Older versions of the PLC firmware may or may not provide EtherNet/IP functionality. You must verify that an older version of the PLC firmware provides EtherNet/IP functionality before you can use it with IO-Link Master.

If you need to update your PLC firmware, contact your Rockwell distributor.

14.2 PLC-5 and SLC 5/05 PLC Requirements

The following PLCs support Ethernet/IP.

14.2.1 SLC 5/05

Models	Catalog Numbers	Required Firmware Version for Ethernet/IP
SLC 5/05	1747-L551 1747-L552 1747-L553	Series A: FRN 5 or later Series C: FRN 3 or later

Reference:

SLC 500 Instruction Set, Appendix A Firmware History, Rockwell Publication 1747-RM001D-EN-P.

14.2.2 PLC-5

Models	Catalog Numbers	Required Firmware Version for Ethernet/IP
Ethernet PLC-5	1785-L20E 1785-L40E 1785-L80E	Base Ethernet/IP functionality: <ul style="list-style-type: none"> • Series C: Revision N and later • Series D: Revision E and later • Series E: Revision D and later Full Ethernet/IP Compliance: <ul style="list-style-type: none"> • Series C: Revision R and later • Series D: Revision H and later • Series E: Revision G and later
Enhanced PLC-5 Attached to Ethernet Module	1785-L11B 1785-L20B 1785-L30B 1785-L40B 1785-L40L 1785-L60B 1785-L60L 1785-L80B	Series B: Revision N.1 or later Series C: Revision N or later Series D: Revision E or later Series E: Revision D or later
ControlNet PLC-5 Attached to Ethernet Module	1785-L20C15 1785-L40C15 1785-L60C15 1785-L80C15	Series C: Revision N or later Series D: Revision E or later Series E: Revision D or later All revisions
Ethernet Module	1785-Enet	Series B: <ul style="list-style-type: none"> • Base Ethernet/IP functionality: All Revisions • Full Ethernet/IP Compliance: Revision D and later

References:

- Enhanced & Ethernet PLC-5 Series and Enhancement History, Rockwell Publication G19099
- ControlNet Processor Phase, Series, and Enhancement History, Rockwell Publication G19102
- PLC-5 Programmable Controllers System Selection Guide, Rockwell Publication 1785-SG001A-EN-P
- Ethernet Interface Module Series B, Revision D Product Release Notes, Rockwell Publication 1785- RN191E-EN-P

Note: Older versions of firmware may or may not provide Ethernet/IP functionality.

14.3 PLC-5 and SLC Messages

The following PCCC messages are supported for the PLC-5 and SLC 5/05 PLCs.

Message Type	PCCC Message ID	Maximum Message Size	Maximum Serial Packet Size
SLC Typed Read	162	CLX: 242 SINTs (121 INTs) SLC: 206 SINTs (103 INTs) PLC-5: 240 SINTs (120 INTs)	CLX: 238 SINTs (119 INTs) SLC: 202 SINTs (101 INTs) PLC-5: 236 SINTs (118 INTs)
SLC Typed Write	170	CLX: 220 SINTs (110 INTs) SLC: 206 SINTs (103 INTs) PLC-5: 238 SINTs (119 INTs)	216 SINTs (108 INTs) SLC: 202 SINTs (101 INTs) PLC-5: 234 SINTs (117 INTs)
PLC-5 Typed Read	104	CLX: 234 SINTs (117 INTs) SLC: 252 SINTs (126 INTs) PLC-5: 238 SINTs (119 INTs)	230 SINTs (115 INTs) SLC: 248 SINTs (124 INTs) PLC-5: 234 SINTs (117 INTs)

Message Type	PCCC Message ID	Maximum Message Size	Maximum Serial Packet Size
PLC-5 Typed Write	103	CLX: 226 SINTs (113 INTs) SLC: 226 SINTs (113 INTs) PLC-5: 224 SINTs (112 INTs)	CLX: 222 SINTs (111 INTs) SLC: 222 SINTs (111 INTs) PLC-5: 220 SINTs (110 INTs)

The Receive Port Information is provided in one continuous file. The following file addresses are used to retrieve the various parameters.

	IO-Link Port 1	IO-Link Port 2	IO-Link Port 3	IO-Link Port 4	Access	Length
PDI Data Block	N10:0	N20:0	N30:0	N40:0	Read-Only	Configurable per port <i>Note: See below for details.</i>
Receive PDO Data Block	N11:0	N21:0	N31:0	N41:0	Read-Only	Configurable per port <i>Note: See below for details.</i>
Transmit PDO Data Block	N12:0	N22:0	N32:0	N42:0	Write- Only	Configurable per port <i>Note: See below for details.</i>
Receive ISDU Response	N13:0	N23:0	N33:0	N43:0	Read-Only	4 INTs to Max Msg Size
Transmit ISDU Request	N14:0	N24:0	N34:0	N44:0	Write- Only	4 INTs to Max Msg Size
<i>Port Information Block (Continuous Block)</i>						464 Bytes (232 INTs)
Vendor Name	N15:0	N25:0	N35:0	N45:0	Read	64 Chars (32 INTs)
Vendor Text	N15:32	N25:32	N35:32	N45:32	Read	64 Chars (32 INTs)
Product Name	N15:64	N25:64	N35:64	N45:64	Read	64 Chars (32 INTs)
Product ID	N15:96	N25:96	N35:96	N45:96	Read	64 Chars (32 INTs)
Product Text	N15:128	N25:128	N35:128	N45:128	Read	64 Chars (32 INTs)
Serial Number	N15:160	N25:160	N35:160	N45:160	Read	16 Chars (8 INTs)
Hardware Revision	N15:168	N25:168	N35:168	N45:168	Read	64 Chars (32 INTs)
Firmware Revision	N15:200	N25:200	N35:200	N45:200	Read	64 Chars (32 INTs)

This table provides information for 8-port models.

	IO-Link Port 5	IO-Link Port 6	IO-Link Port 7	IO-Link Port 8	Access	Length
PDI Data Block	N50:0	N60:0	N70:0	N80:0	Read-Only	Configurable per port <i>Note: See below for details.</i>
Receive PDO Data Block	N51:0	N61:0	N71:0	N81:0	Read-Only	Configurable per port <i>Note: See below for details.</i>
Transmit PDO Data Block	N52:0	N62:0	N72:0	N82:0	Write- Only	Configurable per port <i>Note: See below for details.</i>
Receive ISDU Response	N53:0	N63:0	N73:0	N83:0	Read-Only	4 INTs to Max Msg Size
Transmit ISDU Request	N54:0	N64:0	N74:0	N84:0	Write- Only	4 INTs to Max Msg Size
<i>Port Information Block (Continuous Block)</i>						464 Bytes (232 INTs)
Vendor Name	N55:0	N65:0	N75:0	N85:0	Read	64 Chars (32 INTs)
Vendor Text	N55:32	N65:32	N75:32	N85:32	Read	64 Chars (32 INTs)
Product Name	N55:64	N65:64	N75:64	N85:64	Read	64 Chars (32 INTs)
Product ID	N55:96	N65:96	N75:96	N85:96	Read	64 Chars (32 INTs)
Product Text	N55:128	N65:128	N75:128	N85:128	Read	64 Chars (32 INTs)
Serial Number	N55:160	N65:160	N75:160	N85:160	Read	16 Chars (8 INTs)
Hardware Revision	N55:168	N65:168	N75:168	N85:168	Read	64 Chars (32 INTs)
Firmware Revision	N55:200	N65:200	N75:200	N85:200	Read	64 Chars (32 INTs)

14.4 Process Data (PDI and PDO) Access via PCCC Messages

The process data has been grouped together in order to minimize the number of PCCC messages required to interface to the IO-Link Master. The PDI and PDO data for multiple ports can be received or transmitted by one message.

	File Number	Controller Port 1 Access		Controller Port 2 Access		Controller Port 3 Access		Controller Port 4 Access	
		Read (Input)	Write (Output)	Read (Input)	Write (Output)	Read (Input)	Write (Output)	Read (Input)	Write (Output)
Read (Input) Process Data Input (Ports 5-8 Only Supported on 8- Port Models)	N10:0 (Port 1)								
	N20:0 (Port 2)								
	N30:0 (Port 3)								
	N40:0 (Port 4)								
	N50:0 (Port 5)								
	N60:0 (Port 6)								
	N70:0 (Port 7)								
	N80:0 (Port 8)								
Read (Input) Process Data Output (Ports 5-8 Only Supported on 8- Port Models)	N11:0 (Port 1)								
	N21:0 (Port 2)								
	N31:0 (Port 3)								
	N41:0 (Port 4)								
	N51:0 (Port 5)								
	N61:0 (Port 6)								
	N71:0 (Port 7)								
	N81:0 (Port 8)								

	File Number	Controller Port 1 Access		Controller Port 2 Access		Controller Port 3 Access		Controller Port 4 Access	
		Read (Input)	Write (Output)	Read (Input)	Write (Output)	Read (Input)	Write (Output)	Read (Input)	Write (Output)
Write (Output) Process Data Output (Ports 5-8 Only Supported on 8-Port Models)	N12:0 (Port 1)								
	N22:0 (Port 2)								
	N32:0 (Port 3)								
	N42:0 (Port 4)								
	N52:0 (Port 5)								
	N62:0 (Port 6)								
	N72:0 (Port 7)								
	N82:0 (Port 8)								

PCCC Read/Write Access *where:*

- All PDI data can be read with one PCCC read message.
- All PDO data can be read with one PCCC read message.
- All PDO data can be written with one PCCC write message.
- Controller Read access:
 - The PDI data from one or more ports may be read with one message. (That is, if addressing Port 1, N10:0, ports one to four may be read in one message.)
 - The PDO data from one or more ports may be read with one message. (That is, if addressing Port 1, N11:0, ports one to four may be read in one message.)
 - Partial PDI and PDO data reads are allowed.
 - The length of the Read message can range from 1 to the total, configured PDI or PDO length for all ports starting at the addressed port.
- Controller Write (Output) access:
 - Only PDO data may be written.
 - The PDO data for one or more ports may be written with one message.
 - Partial PDO data writes are not allowed.
 - The length of the Write message must be equal to the total of the configured PDO lengths for all ports to be written. The one exception is that the data length of the last port to be written must be equal to or greater than the device PDO length for that port.

15 EDS Files

This chapter discusses the following topics:

- *Downloading the Files, see Chapter 15.2*
- *Adding the IO-Link Master to RSLinx, see Chapter 15.3*
- *Adding EDS Files to RSLinx, see Chapter 15.4*

15.1 Overview

You do not need to add the IO-Link Master to RSLinx for normal IO-Link Master-to-PLC communications. However, you can easily add the IO-Link Master and its associated Electronic Data Sheet (EDS) files to RSLinx.

The files named **IO-Link Master_*.ico** are icon files and files named **IO-Link Master_dd_NNNN-x.xx.eds** are ODVA electronic data sheet files where:

- **dd** is the model name
- **NNNN** is the product ID number
- **x.xx** is the version number

15.2 Downloading the Files

You can download the EDS files provided for the IO-Link Master from the Leuze electronic web site.

15.3 Adding the IO-Link Master to RSLinx

You can use these steps to add the IO-Link Master to RSLinx.

1. Open RSLinx.
2. Under **Communications**, select **Configure Drivers**.
3. Under **Available Drivers**, select **Remote Devices via Linx Gateway**.
4. Select **Add New**.
5. Use the default driver name or type your own driver name and click **OK** to continue.
6. Type the IP address for the device under **Server's IP Address or Hostname** and select **OK**.
7. Select **RSWho** to verify that **RSLinx** can communicate with the IO-Link Master.

***Note:** A yellow question mark appears by the IO-Link Master(s) in the RSWho window when the associated EDS file(s) are not installed.*

15.4 Adding EDS Files to RSLinx

You can use this procedure to add the EDS files to RSLinx.

1. Open the **EDS Hardware Installation Tool**. (Select **Start > All Programs > Rockwell Software > RSLinx Tools**.)
2. Click **Add**.
3. Click **Register a directory of EDS files**.
4. Browse to the **Leuze electronic/EtherNetIP** directory and click **Next** to continue.
5. Verify that there is a green check beside each EDS file name and select **Next** to continue.
6. To change the icons, perform the following tasks.
 - a. Select an IO-Link Master.
 - b. Select **Change icon**.
 - c. Browse to the **Leuze electronic/EtherNetIP** directory and select the icon associated with your IO-Link Master.
7. Click **Finish** to exit.

If RSLinx does not display the device after adding IO-Link Master and the EDS files to RSLinx, perform the following procedure:

1. Select **File > Exit and Shutdown** to exit and shutdown RSLinx.
2. Remove the following files from your hard drive:
\\Program Files\Rockwell Software\RSCOMMON\Harmony.hrc
\\Program Files\Rockwell Software\RSCOMMON\Harmony.rsh
3. Restart RSLinx. The IO-Link Master or IO-Link Masters should now appear with the associated icon or icons.

16 Modbus/TCP Interface

The IO-Link Master provides a slave-mode Modbus/TCP interface that provides:

- Read access to the PDI and PDO data blocks for each IO-Link port
- Write access to the PDO data block for each IO-Link port
- Write access to send SPDU requests to each IO-Link port
- Read access to SPDU responses from each IO-Link port
- Read access to the Port Information Block for each IO-Link port

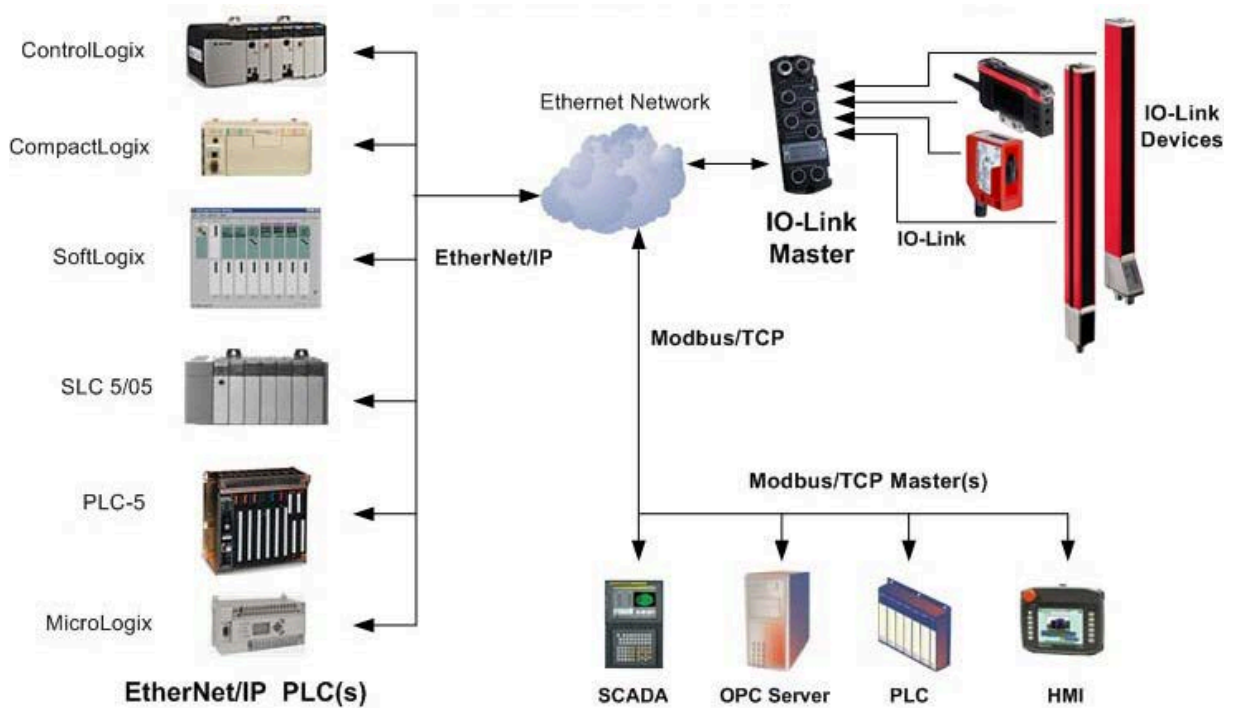

Figure 59: Modbus/TCP to IO-Link

16.1 Modbus Function Codes

This table shows the supported Modbus function codes.

Message Type	Function Code	Maximum Message Size
Read Holding Registers	3	250 Bytes (125 Words)
Write Single Register	6	2 bytes (1 Word)
Write Multiple Registers	16 (10 hex)	246 Bytes (123 Words)
Read/Write Holder Registers	23 (17 hex)	Write: 242 bytes (121 Words) Read: 246 bytes (123 Words)

16.2 Modbus Address Definitions

The address definitions for the Modbus/TCP interface are shown in the following tables.

	IO-Link Port 1	IO-Link Port 2	IO-Link Port 3	IO-Link Port 4	Access	Length
Multiple Port PDI Data Block(s)	999 (Base 0) 1000 (Base 1)	1999 (Base 0) 2000 (Base 1)	2999 (Base 0) 3000 (Base 1)	3999 (Base 0) 4000 (Base 1)	Read-Only	Configurable per port (s)
Port Specific PDI Data Block	1000 (Base 0) 1001 (Base 1)	2000 (Base 0) 2001 (Base 1)	3000 (Base 0) 3001 (Base 1)	4000 (Base 0) 4001 (Base 1)	Read-Only	Configurable per port
Multiple Port PDO Data Block(s)	1049 (Base 0) 1050 (Base 1)	2049 (Base 0) 2050 (Base 1)	3049 (Base 0) 3050 (Base 1)	4049 (Base 0) 4050 (Base 1)	Read/Write	Configurable per port(s)
Port Specific PDO Data Block	1050 (Base 0) 1051 (Base 1)	2050 (Base 0) 2051 (Base 1)	3050 (Base 0) 3051 (Base 1)	4050 (Base 0) 4051 (Base 1)	Read/Write	Configurable per port
Receive SPDU Response	1100 (Base 0) 1101 (Base 1)	2100 (Base 0) 2101 (Base 1)	3100 (Base 0) 3101 (Base 1)	4100 (Base 0) 4101 (Base 1)	Read-Only	4 to 125 Words
Transmit SPDU Request	1300 (Base 0) 1301 (Base 1)	2300 (Base 0) 2301 (Base 1)	3300 (Base 0) 3301 (Base 1)	4300 (Base 0) 4301 (Base 1)	Write-Only	4 to 123 Words
<i>Port Information Block (Continuous Block)</i>						232 Words
Vendor Name	1500 (Base 0) 1501 (Base 1)	2500 (Base 0) 2501 (Base 1)	3500 (Base 0) 3501 (Base 1)	4500 (Base 0) 4501 (Base 1)	Read-Only	64 Chars 32 Words
Vendor Text	1532 (Base 0) 1533 (Base 1)	2532 (Base 0) 2533 (Base 1)	3532 (Base 0) 3533 (Base 1)	4532 (Base 0) 4533 (Base 1)	Read-Only	64 Chars 32 Words
Product Name	1564 (Base 0) 1565 (Base 1)	2564 (Base 0) 2565 (Base 1)	3564 (Base 0) 3565 (Base 1)	4564 (Base 0) 4565 (Base 1)	Read-Only	64 Chars 32 Words
Product Id	1596 (Base 0) 1597 (Base 1)	2596 (Base 0) 2597 (Base 1)	3596 (Base 0) 3597 (Base 1)	4596 (Base 0) 4597 (Base 1)	Read-Only	64 Chars 32 Words
Product Text	1628 (Base 0) 1629 (Base 1)	2628 (Base 0) 2629 (Base 1)	3628 (Base 0) 3629 (Base 1)	4628 (Base 0) 4629 (Base 1)	Read-Only	64 Chars 32 Words
Serial Number	1660 (Base 0) 1661 (Base 1)	2660 (Base 0) 2661 (Base 1)	3660 (Base 0) 3661 (Base 1)	4660 (Base 0) 4661 (Base 1)	Read-Only	16 Chars 8 Words
Hardware Revision	1668 (Base 0) 1669 (Base 1)	2668 (Base 0) 2669 (Base 1)	3668 (Base 0) 3669 (Base 1)	4668 (Base 0) 4669 (Base 1)	Read-Only	64 Chars 32 Words
Firmware Revision	1700 (Base 0) 1701 (Base 1)	2700 (Base 0) 2701 (Base 1)	3700 (Base 0) 3701 (Base 1)	4700 (Base 0) 4701 (Base 1)	Read-Only	64 Chars 32 Words
Device PDI Length	1732 (Base 0) 1733 (Base 1)	2732 (Base 0) 2733 (Base 1)	3732 (Base 0) 3733 (Base 1)	4732 (Base 0) 4733 (Base 1)	Read-Only	1 Word
Device PDO Length	1733 (Base 0) 1734 (Base 1)	2733 (Base 0) 2734 (Base 1)	3733 (Base 0) 3734 (Base 1)	4733 (Base 0) 4734 (Base 1)	Read-Only	1 Word

16.2.1 8-Port Models

	IO-Link Port 5	IO-Link Port 6	IO-Link Port 7	IO-Link Port 8	Access	Length
Multiple Port PDI Data Block(s)	4999 (Base 0) 5000 (Base 1)	5999 (Base 0) 6000 (Base 1)	6999 (Base 0) 7000 (Base 1)	7999 (Base 0) 8000 (Base 1)	Read-Only	Configurable per port (s)
Port Specific PDI Data Block	5000 (Base 0) 5001 (Base 1)	6000 (Base 0) 6001 (Base 1)	7000 (Base 0) 7001 (Base 1)	8000 (Base 0) 8001 (Base 1)	Read-Only	Configurable per port
Multiple Port PDO Data Block(s)	5049 (Base 0) 5050 (Base 1)	6049 (Base 0) 6050 (Base 1)	7049 (Base 0) 7050 (Base 1)	8049 (Base 0) 8050 (Base 1)	Read/Write	Configurable per port(s)
Port Specific PDO Data Block	5050 (Base 0) 5051 (Base 1)	6050 (Base 0) 6051 (Base 1)	7050 (Base 0) 7051 (Base 1)	8050 (Base 0) 8051 (Base 1)	Read/Write	Configurable per port
Receive SPDU Response	5100 (Base 0) 5101 (Base 1)	6100 (Base 0) 6101 (Base 1)	7100 (Base 0) 7101 (Base 1)	8100 (Base 0) 8101 (Base 1)	Read-Only	4 to 125 Words
Transmit SPDU Request	5300 (Base 0) 5301 (Base 1)	6300 (Base 0) 6301 (Base 1)	7300 (Base 0) 7301 (Base 1)	8300 (Base 0) 8301 (Base 1)	Write-Only	4 to 123 Words
<i>Port Information Block (Continuous Block)</i>						232 Words
Vendor Name	5500 (Base 0) 5501 (Base 1)	6500 (Base 0) 6501 (Base 1)	7500 (Base 0) 7501 (Base 1)	8500 (Base 0) 8501 (Base 1)	Read-Only	64 Chars 32 Words
Vendor Text	5532 (Base 0) 5533 (Base 1)	6532 (Base 0) 6533 (Base 1)	7532 (Base 0) 7533 (Base 1)	8532 (Base 0) 8533 (Base 1)	Read-Only	64 Chars 32 Words
Product Name	5564 (Base 0) 5565 (Base 1)	6564 (Base 0) 6565 (Base 1)	7564 (Base 0) 7565 (Base 1)	8564 (Base 0) 8565 (Base 1)	Read-Only	64 Chars 32 Words
Product Id	5596 (Base 0) 5597 (Base 1)	6596 (Base 0) 6597 (Base 1)	7596 (Base 0) 7597 (Base 1)	8596 (Base 0) 8597 (Base 1)	Read-Only	64 Chars 32 Words
Product Text	5628 (Base 0) 5629 (Base 1)	6628 (Base 0) 6629 (Base 1)	7628 (Base 0) 7629 (Base 1)	8628 (Base 0) 8629 (Base 1)	Read-Only	64 Chars 32 Words
Serial Number	5660 (Base 0) 5661 (Base 1)	6660 (Base 0) 6661 (Base 1)	7660 (Base 0) 7661 (Base 1)	8660 (Base 0) 8661 (Base 1)	Read-Only	16 Chars 8 Words
Hardware Revision	5668 (Base 0) 5669 (Base 1)	6668 (Base 0) 6669 (Base 1)	7668 (Base 0) 7669 (Base 1)	8668 (Base 0) 8669 (Base 1)	Read-Only	64 Chars 32 Words
Firmware Revision	5700 (Base 0) 5701 (Base 1)	6700 (Base 0) 6701 (Base 1)	7700 (Base 0) 7701 (Base 1)	8700 (Base 0) 8701 (Base 1)	Read-Only	64 Chars 32 Words
Device PDI Length	5732 (Base 0) 5733 (Base 1)	6732 (Base 0) 6733 (Base 1)	7732 (Base 0) 7733 (Base 1)	8732 (Base 0) 8733 (Base 1)	Read-Only	1 Word
Device PDO Length	5733 (Base 0) 5734 (Base 1)	6733 (Base 0) 6734 (Base 1)	7733 (Base 0) 7734 (Base 1)	8733 (Base 0) 8734 (Base 1)	Read-Only	1 Word

16.3 Multiple Port Process Data (PDI/PDO) Access via Modbus/TCP

The process data has been grouped together in order to minimize the number of Modbus messages required to interface to the IO-Link master. The PDI and PDO data for multiple ports can be received or transmitted by one message.

	Modbus Holding Register Address (Base 1)	Controller Port 1 Access		Controller Port 2 Access		Controller Port 3 Access		Controller Port 4 Access	
		Read (Input)	Write (Output)	Read (Input)	Write (Output)	Read (Input)	Write (Output)	Read (Input)	Write (Output)
Read (Input) Process Data Input	1000 (Port 1)								
	2000 (Port 2)								
	3000 (Port 3)								
	4000 (Port 4)								
Read (Input) Process Data Output	1050 (Port 1)								
	2050 (Port 2)								
	3050 (Port 3)								
	4050 (Port 4)								
Write (Output) Process Data Output	1050 (Port 1)								
	2050 (Port 2)								
	3050 (Port 3)								
	4050 (Port 4)								
Read (Input) Process Data Input	5000 (Port 5)								
	6000 (Port 6)								
	7000 (Port 7)								
	8000 (Port 8)								

	Modbus Holding Register Address (Base 1)	Controller Port 1 Access		Controller Port 2 Access		Controller Port 3 Access		Controller Port 4 Access	
		Read (Input)	Write (Output)	Read (Input)	Write (Output)	Read (Input)	Write (Output)	Read (Input)	Write (Output)
Read (Input) Process Data Output	5050 (Port 5)								
	6050 (Port 6)								
	7050 (Port 7)								
	8050 (Port 8)								
Write (Output) Process Data Output	5050 (Port 5)								
	6050 (Port 6)								
	7050 (Port 7)								
	8050 (Port 8)								

To receive and transmit process data for eight ports, it may be necessary to adjust the size of the PDI/PDO data blocks.

Modbus Read/Write Access where:

- All PDI data can be read with one Modbus Read Holding Registers message.
- All PDO data can be read with one Modbus Read Holding Registers read message.
- All PDO data can be written with one Modbus Write Holding Registers message.
- Controller Read access:
 - The PDI data from one or more ports may be read with one message. (i.e.: If addressing port 1, at address 1000, ports one to four may be read in one message.)
 - The PDO data from one or more ports may be read with one message. (i.e.: If addressing port 1, at address 1050, ports one to four may be read in one message.)
 - Partial PDI and PDO data reads are allowed.
 - The length of the Read message can range from 1 to the total, configured PDI or PDO length for all ports starting at the addressed port.
- Controller Write (Output) access:
 - Only PDO data may be written.
 - The PDO data for one or more ports may be written with one Write Holding Registers message.
 - Partial PDO data writes are not allowed.
 - The length of the Write message must be equal to the total of the configured PDO lengths for all ports to be written. The one exception is that the data length of the last port to be written must be equal to or greater than the device PDO length for that port.

17 Functionality Descriptions

This chapter discusses the following:

- *Process Data Block Descriptions; see Chapter 17.1*
- *Event Handling, see Chapter 17.2*
- *ISDU Handling, see Chapter 17.3*

17.1 Process Data Block Descriptions

This chapter discusses the following:

- *Input Process Data Block Description, see Chapter 17.1.1*
- *Output Process Data Block Description, see Chapter 17.1.2*

17.1.1 Input Process Data Block Description

The Input Process Data Block format is dependent on the configured PDI Data Format. The following tables describe the Input Process Data Block in the possible formats.

Parameter Name	Data Type	Description
Port Status	BYTE	<p>The status of the IO-Link device.</p> <p>Bit 0 (0x01): 0 = IO-Link port communication initialization process is inactive 1 = IO-Link port communication initialization process is active</p> <p>Bit 1 (0x02): 0 = IO-Link port communication is not operational 1 = IO-Link port communication is operational</p> <p>Bit 2 (0x04): 0 = IO-Link input process data is not valid. 1 = IO-Link input process data is valid.</p> <p>Bit 3 (0x08): 0= No fault detected 1= Fault detected</p> <ul style="list-style-type: none"> • A minor communication fault is indicated by the Operational status bit being set to 1. A minor communication fault results from: <ul style="list-style-type: none"> ○ A temporary loss of communication to the IO-Link device. ○ A recoverable IO-Link Master software or hardware fault. • A major communication fault is indicated by the Operational bit being set to 0. <ul style="list-style-type: none"> ○ An unrecoverable loss of communication to the IO-Link device. ○ An unrecoverable IO-Link Master software or hardware fault. <p>Bits 4-7: Reserved (0)</p>

Parameter Name	Data Type	Description
Auxiliary I/O 	BYTE	Auxiliary I/O: <i>Note: The auxiliary bit on the IO-Link port is Pin 2 on the MD 758i-11- 42/L5-2222 and DI on the MD 258i-12-8K/L4-2R2K.</i> Bit 0 (0x01): The status of the auxiliary bit. 0 = off 1 = on Bits 1-3: Reserved (0) If Include Digital I/O in PDI Data Block is disabled: Bits 4-7: Reserved (0) If Include Digital I/O in PDI Data Block is enabled: Bits 4-7: Bit 4 (0x10) – L+ input status Bit 5 (0x20) – DI I/O status Bit 6 (0x40) – L- input status Bit 7 (0x80) – C/Q I/O status
Event Code	INT	16-bit event code received from the IO-Link device.
PDI Data <i>Default Length = 32 bytes</i>	Array of up to 32 BYTEs	The PDI data as received from the IO-Link device. May contain from 0 to 32 bytes of PDI data. The definition of the PDI data is device dependent. <i>Note: Length is configurable using the web page interface.</i>

17.1.1.1 Input Process Data Block-8 Bit Data Format

The following table provides detailed information about the Input Process Data Block-8 Bit data format.

Byte	Bit 7	Bit 0
0	Port Status	
1	Auxiliary I/O	
2	Event Code LSB	
3	Event Code MSB	
4	PDI Data Byte 0	
5	PDI Data Byte 1	
..	..	
..	..	
N+3	PDI Data Byte (N-1)	

17.1.1.2 Input Process Data Block-16 Bit Data Format

The following table provides detailed information about the Input Process Data Block-16 data format.

Word	Bit 15	Bit 8	Bit 7	Bit 0
0	Port Status		Auxiliary I/O	
1	Event Code			
2	PDI Data Word 0			
3	PDI Data Word 1			
..	..			

Word	Bit 15	Bit 8	Bit 7	Bit 0
..	..			
N+1	PDI Data Word (N-1)			

17.1.1.3 Input Process Data Block-32 Bit Data Format

The following table provides detailed information about the Input Process Data Block-32 Bit data format.

Long Word	Bit 31	Bit 24	Bit 23	Bit 16	Bit 15	Bit 0
0	Port Status		Auxiliary I/O		Event Code	
2	PDI Data Long Word 0					
3	PDI Data Long Word 1					
..	..					
N	PDI Data Long Word (N-1)					

17.1.2 Output Process Data Block Description

The contents of the Output Process Data Block are configurable.

Parameter Name	Data	Description
Clear Event Code in PDO Block (Configurable option) <i>Default:</i> Not included	INT	If included, allows clearing of 16-bit event code received in the PDI data block via the PDU data block.
Include Digital Output(s) in PDO Data Block <i>Default:</i> Not included	INT	If included, allows setting the Digital Output Pins D2 and D4.
PDO Data Default Length = 32 bytes	Array of up to 32 BYTES	The PDO data written to the IO-Link device. May contain from 0 to 32 bytes of PDO data. The definition and length of the PDO data is device dependent. Note: Length is configurable via web page interface.

17.1.2.1 Output Process Data Block-8 Bit (SINT) Data Format

Without either the **Clear Event Code in PDO Block** or **Include Digital Output(s) in PDO Data Block** options selected:

Byte	Bit 7	Bit 0
0	PDO Data Byte 0	
1	PDO Data Byte 1	
..	..	
..	..	
N-1	PDO Data Byte (N-1)	

With the **Clear Event Code in PDO Block** option selected and without the **Include Digital Output(s) in PDO Data Block** option selected:

Byte	Bit 7	Bit 0
0	Event Code LSB	
1	Event Code MSB	
2	PDO Data Byte 0	
3	PDO Data Byte 1	
..	..	
..	..	
N+1	PDO Data Byte (N-1)	

With both the **Clear Event Code in PDO Block** and **Include Digital Output(s) in PDO Data Block** options selected:

Byte	Bit 7	Bit 0
0	Event code LSB	
1	Event code MSB	
2	Digital Output Settings: Bit 1 (0x02) - DI setting Bit 3 (08x08) - C/Q setting	
3	0 (Unused)	
4	PDO Data Byte 0	
5	PDO Data Byte 1	
..	..	
..	..	
N + 3	PDO Data Byte (N-1)	

17.1.2.2 Output Process Data Block-16 Bit (INT) Data Format

Without either the **Clear Event Code in PDO Block** or **Include Digital Output(s) in PDO Data Block** options selected:

Word	Bit 15	Bit 0
0	PDO Data Word 0	
1	PDO Data Word 1	
..	..	
..	..	
N-1	PDO Data Word (N-1)	

With the **Clear Event Code in PDO Block** option selected and without the **Include Digital Output(s) in PDO Data Block** option selected:

Word	Bit 15	Bit 0
0	Event Code	
1	PDO Data Word 0	
2	PDO Data Word 1	
..	..	
..	..	
N	PDO Data Word (N-1)	

With both the **Clear Event Code in PDO Block** and **Include Digital Output(s) in PCO Data Block** options selected:

Word	Bit 15	Bit 0
0	Event Code	
1	Digital Output Settings: Bit 1 (0x02) - DI setting Bit 3 (08x08) - C/Q setting	
2	PDO Data Word 0	
3	PDO Data Word 1	
..	..	
..	..	
N+1	PDO Data Word (N-1)	

17.1.2.3 Output Process Data Block-32 Bit (DINT) Data Format

Without either the **Clear Event Code in PDO Block** or **Include Digital Output(s) in PDO Data Block** options selected:

Long Word	Bit 31	Bit 0
0	PDO Data Long Word 0	
1	PDO Data Long Word 1	
..	..	
..	..	
N-1	PDO Data Long Word (N-1)	

With the **Clear Event Code in PDO Block** option selected and without the **Include Digital Output(s) in PDO Data Block** option selected:

Long Word	Bit 31	Bit 16	Bit 15	Bit 0
0	0		Event Code	
1	PDO Data Long Word 0			
2	PDO Data Long Word 1			
..	..			
..	..			
N - 1	PDO Data Long Word (N-1)			

With both the **Clear Event Code in PDO Block** and **Include Digital Output(s) in PDO Data Block** options selected:

Long Word	Bit 31	Bit 16	Bit 15	Bit 0
0	Digital Output Settings: Bit 17 (0x0002) – DI setting Bit 19 (0x0008) – C/Q setting		Event Code	
1	PDO Data Long Word 0			
2	PDO Data Long Word 1			
..	..			
..	..			
N - 1	PDO Data Long Word (N-1)			

17.2 Event Handling

The IO-Link Master event handling is designed to provide real-time updates of event codes received directly from the IO-Link device. The IO-Link event code:

- Is included in the second 16-bit word of the Input Process Data (PDI) block.
 - An active event is indicated by a non-zero value.
 - Inactive or no event is indicated by a zero value.
- Two methods are provided to clear an event:
 - Enable the Clear Event After Hold Time option.
 - The IO-Link Master keeps, or holds, the active event code in the PDI block until the configured *Active Event Hold Time* has passed.
 - The IO-Link Master then clears the event code in the PDI block and waits until the *Clear Event Hold Time* has passed before including another event code in the PDI block.
 - Enable the *Clear Event In PDO Block* option.
 - The IO-Link Master monitors the PDO block received from the PLC.
 - The IO-Link Master expects the first entry of the PDO block to indicate an event code to be cleared.
 - If there is an active event code in the PDI block and the PDO block both contain the same event code, the event code is cleared in the PDI block.
 - The IO-Link Master then clears event code in the PDI block and waits until the *Clear Event Hold Time* has passed before including another event code in the PDI block.
- The two methods can be used separately or together to control clearing of events.

The next subsections illustrate the event clearing process for the various event configurations.

17.2.1 Clear Event After Hold Time Process

This illustrates clearing the event after the hold time process.

17.2.2 Clear Event in PDO Block Process

This illustrates clearing the event in the PDO block process.

17.2.3 Clear Event Code in PDO Block and Clear Event After Hold Time Process- PDO Block First

This illustrates clearing the event code in the PDO block and clearing the event after the hold time process with the PDO block first.

17.2.4 Clear Event Code in PDO Block and Clear Event After Hold Time Process- Hold Time Expires

This illustrates clearing the event code in the PDO block and clearing the event after the hold time process with the hold time expired.

17.3 ISDU Handling

The IO-Link Master provides a very flexible ISDU interface that is used by all supported industrial protocols. The ISDU interface contains the following:

- An ISDU *request* may contain **one or multiple** individual ISDU read and/or write *commands*.
- Individual ISDU command based **byte swapping** capabilities.
- **Va riable sized** command structures to allow access to wide range of ISDU block sizes.
- A single ISDU request may contain as many ISDU read and/or write commands as allowed by the industrial protocol payload. For example, if an industrial protocol provides up to 500 byte read/write payloads, then an ISDU request may contain multiple commands of various lengths that can total up to 500 bytes in length.
- For the ControlLogix family of EtherNet/IP PLCs, both blocking and non-blocking ISDU request methods are provided.
 - The IO-Link Master implements blocking ISDU requests by not responding to an ISDU request message until all commands have been processed.
 - The IO-Link Master implements non-blocking ISDU requests by:
 - Responding to an ISDU request message immediately after receiving and verifying the ISDU request.
 - Requiring the PLC to monitor the ISDU request status with read messages. The IO-Link Master will not return a completed status until all of the ISDU commands have been processed.

17.3.1 ISDU Request/Response Structure

ISDU requests may contain a single command or multiple, nested commands. This chapter discusses the following:

- *Single ISDU Command Request see Chapter 17.3.1.1*
- *Multiple ISDU Command Structure, see Chapter 17.3.1.2*

17.3.1.1 Single ISDU Command Request

This illustrates a single ISDU command request.

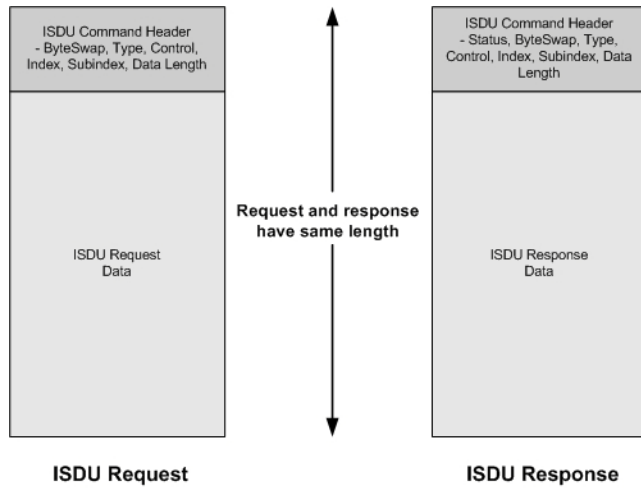

Figure 60: Single Command ISDU Request/Response

17.3.1.2 Multiple ISDU Command Structure

ISDU requests with multiple commands may consist of commands of the same data size or commands with different data sizes. The following are two examples of multiple ISDU commands.

- *Figure 61: Example - Multiple Command ISDU Request/Response of Different Data Area Lengths*
- *Figure 62: Example - Multiple Command ISDU Request/Response of Different Data Area Lengths*

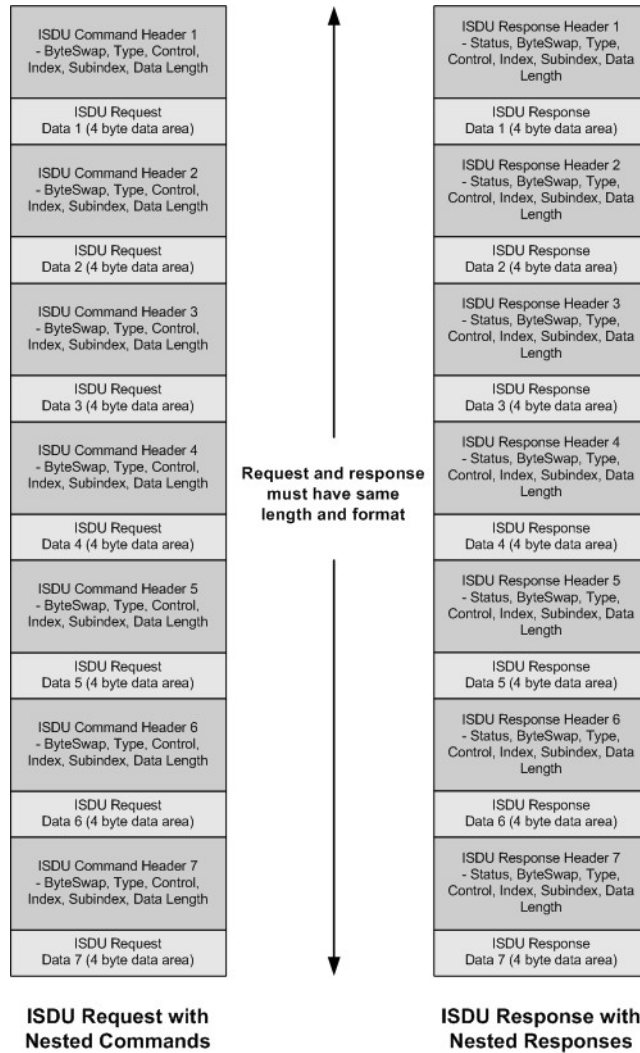

Figure 61: Example - Multiple Command ISDU Request/Response of Different Data Area Lengths

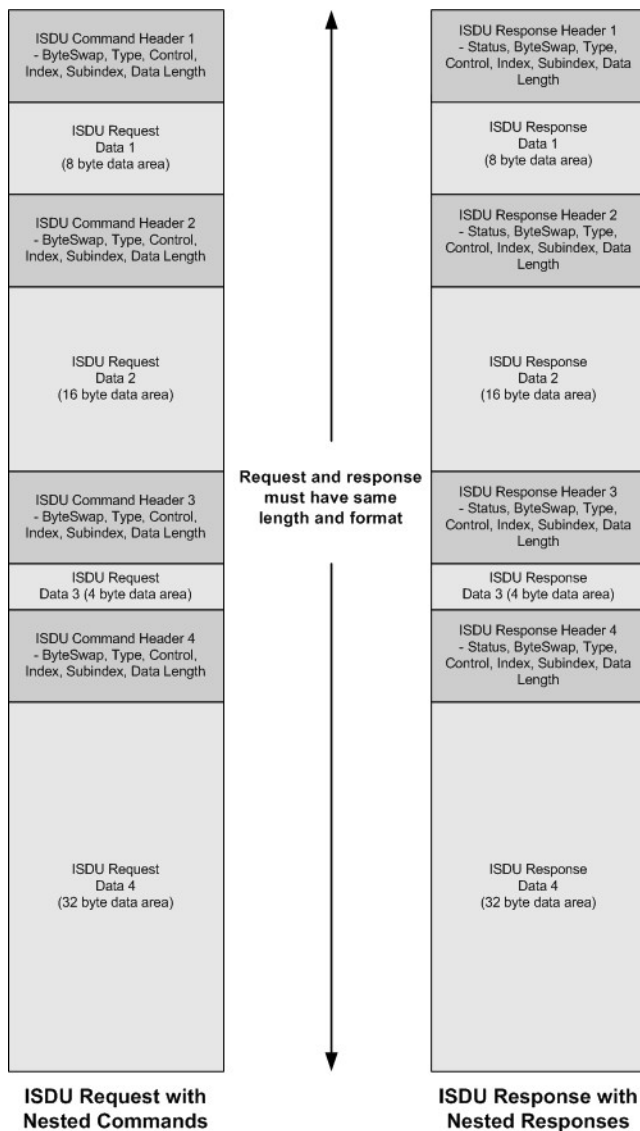

Figure 62: Example – Multiple Command ISDU Request/Response of Different Data Area Lengths

17.3.2 ISDU Request Message Format-From PLC to IO-Link Master

Write and read ISDU commands have the same message data format. Each ISDU request message is comprised of one or more commands. The command(s) can consist of either a series of nested commands or a single read command.

Note: A list of nested ISDU commands is terminated with either a control field of 0, (single/last operation), or the end of the message data.

17.3.2.1 Standard ISDU Request Command Format

This table displays a standard ISDU request command format with ControlLogix PLCs.

Name	Data Type	Parameter Descriptions
Byte Swapping	USINT	<p>Bits 0-3:</p> <ul style="list-style-type: none"> 0= No byte swapping. 1= 16-bit (INT) byte swapping of ISDU data. 2= 32-bit (DINT) byte swapping of ISDU data. <p>Bits 4-7:</p> <ul style="list-style-type: none"> Set to zero. Unused.
RdWrControlType	USINT	<p>Provides the control and type of ISDU command.</p> <p>Bits 0-3, Type Field:</p> <ul style="list-style-type: none"> 0 = NOP (No operation) 1 = Read operation 2 = Write operation 3 = Read/Write "OR" 4 = Read/Write "AND" <p>Bits 4-7, Control Field:</p> <ul style="list-style-type: none"> 0 = Single/Last Operation (length can vary from to 1 to 232) 1 = Nested batch command – fixed 4 byte data area 2 = Nested batch command – fixed 8 byte data area 3 = Nested batch command – fixed 16 byte data area 4 = Nested batch command – fixed 32 byte data area 5 = Nested batch command – fixed 64 byte data area 6 = Nested batch command – fixed 128 byte data area 7 = Nested batch command – fixed 232 byte data area
Index	UINT	The parameter address of the data object in the IO-Link device.
Subindex	UINT	The data element address of a structured parameter of the data object in the IO-Link device.
Datalength	UINT	<p>Length of data to read or write.</p> <p>For nested batch commands, the data length can vary from 1 to the fixed data area size.</p>
Data	Array of USINTs, UINTs, or UDINTs.	<p>Size of array is determined by the Control field in RdWrControlType.</p> <p>Note: <i>Data is valid only for write commands.</i></p>

17.3.2.2 Integer (16-Bit Word) ISDU Request Command Format

This table shows an integer (16 bit word) ISDU request command format with a SLC, MicroLogix, PLC-5, or Modbus/TCP.

Name	Data Type	Parameter Description
Byte Swapping / RdWrControlType	UINT	Provides the control, type and byte swapping of ISDU command Bits 0-3, Type Field: 0 = NOP (No operation) 1 = Read operation 2 = Write operation 3 = Read/Write "OR" 4 = Read/Write "AND" Bits 4-7, Control Field: 0 = Single/Last Operation (length can vary from to 1 to 232) 1 = Nested batch command – fixed 4 byte data area 2 = Nested batch command – fixed 8 byte data area 3 = Nested batch command – fixed 16 byte data area 4 = Nested batch command – fixed 32 byte data area 5 = Nested batch command – fixed 64 byte data area 6 = Nested batch command – fixed 128 byte data area 7 = Nested batch command – fixed 232 byte data area Bits 8-11: 0= No byte swapping. 1= 16-bit (INT) byte swapping of ISDU data. 2= 32-bit (DINT) byte swapping of ISDU data. Bits 12-15: Set to zero. Unused.
Index	UINT	The parameter address of the data object in the IO-Link device.
Subindex	UINT	The data element address of a structured parameter of the data object in the IO-Link device.
Datalength	UINT	Length of data to read or write. For nested batch commands, the data length can vary from 1 to the fixed data area size.
Data	Array of USINTs, UINTs, or UDINTs.	Size of array is determined by the Control field in RdWrControlType . <i>Note: Data is valid only for write commands.</i>

17.3.3 ISDU Response Message Format

The ISDU responses have the same data format as requests with the only exception being the returned command status. Each ISDU response message is comprised of one or more responses to the single and/or nested command(s) received in the request.

17.3.3.1 Standard ISDU Response Command Format

The following table show the standard ISDU response command format with ControlLogix PLCs.

Name	Data Type	Parameter Description
Status	USINT	<p>Indicates the byte alignment and status of the command response.</p> <p>Byte swapping, bits 0-3:</p> <ul style="list-style-type: none"> 0= No byte swapping. 1= 16-bit (INT) byte swapping of TX/RX ISDU data. 2= 32-bit (DINT) byte swapping of TX/RX ISDU data. <p>Status, bits 4-7:</p> <ul style="list-style-type: none"> 0 = NOP (No operation) 1 = In process (Only valid for non-blocking requests) 2 = Success 3 = Failure: IO-Link device rejected the request. 4 = Timed out: IO-Link device did not respond
RdWrControlType	USINT	<p>Provides the control and type of ISDU request</p> <p>Bits 0-3, Type Field:</p> <ul style="list-style-type: none"> 0 = NOP (No operation) 1 = Read operation 2 = Write operation 3 = Read/Write "OR" 4 = Read/Write "AND" <p>Bits 4-7, Control Field:</p> <ul style="list-style-type: none"> 0 = Single/Last Operation (length can vary from to 1 to 232) 1 = Nested batch command – fixed 4 byte data area 2 = Nested batch command – fixed 8 byte data area 3 = Nested batch command – fixed 16 byte data area 4 = Nested batch command – fixed 32 byte data area 5 = Nested batch command – fixed 64 byte data area 6 = Nested batch command – fixed 128 byte data area 7 = Nested batch command – fixed 232 byte data area
Index	UINT	The parameter address of the data object in the IO-Link device.
Subindex	UINT	The data element address of a structured parameter of the data object in the IO-Link device.
Datalength	UINT	<p>Length of data that was read or written.</p> <p>For nested batch commands, the data length can vary from 1 to fixed data area size.</p>
Data	Array of USINTs, UINTs, or UDINTs.	<p>Data required for read commands. Optionally can return the data of a write command.</p> <p>The size of the array is determined by the Control field in the RdWrControlType.</p> <p><i>Note: Data field not required for single NOP commands.</i></p>

17.3.3.2 Integer (16-Bit Word) ISDU Response Command Format

The following table shows an integer (16-bit word) ISDU response command format with SLC, MicroLogix, PLC-5, or Modbus/TCP.

Name	Data Type	Parameter Descriptions
Status, Byte-Swapping, RdWrControlType	UINT	<p>Indicates the control, type, byte swapping and status of the ISDU command.</p> <p>Bits 0-3, Type Field:</p> <ul style="list-style-type: none"> 0 = NOP (No operation) 1 = Read operation 2 = Write operation 3 = Read/Write "OR" 4 = Read/Write "AND" <p>Bits 4-7, Control Field:</p> <ul style="list-style-type: none"> 0 = Single/Last Operation (length can vary from to 1 to 232) 1 = Nested batch command – fixed 4 byte data area 2 = Nested batch command – fixed 8 byte data area 3 = Nested batch command – fixed 16 byte data area 4 = Nested batch command – fixed 32 byte data area 5 = Nested batch command – fixed 64 byte data area 6 = Nested batch command – fixed 128 byte data area 7 = Nested batch command – fixed 232 byte data area <p>Byte swapping, bits 8-11:</p> <ul style="list-style-type: none"> 0= No byte swapping. 1= 16-bit (INT) byte swapping of TX/RX ISDU data. 2= 32-bit (DINT) byte swapping of TX/RX ISDU data. <p>Status, bits 12-15:</p> <ul style="list-style-type: none"> 0 = NOP (No operation) 1 = In process (Only valid for non-blocking requests) 2 = Success 3 = Failure: IO-Link device rejected the request. 4 = Timed out: IO-Link device did not respond
Index	UINT	The parameter address of the data object in the IO-Link device
Subindex	UINT	The data element address of a structured parameter of the data object in the IO-Link device.
Datalength	UINT	<p>Length of data that was read or written.</p> <p>For nested batch commands, the data length can vary from 1 to fixed data area size.</p>
Data	Array of USINTs, UINTs, or UDINTs	<p>Data returned for read commands. Contains the data of a write command.</p> <p>The size of the array is determined by the Control field in RdWrControlType.</p> <p><i>Note: Data field not required for single NOP commands.</i></p>

17.3.4 ISDU Blocking and Non-Blocking Methods

The IO-Link Master supports both blocking and non-blocking ISDU requests. The following diagrams demonstrate how each mode works.

17.3.4.1 Single Command Blocking

The following illustrates the single command blocking method.

17.3.4.2 Multiple Command Blocking

This illustrates the multiple command blocking method.

17.3.4.3 Single Command Non-Blocking

This illustrates the single command non-blocking method.

17.3.4.4 Multiple Command Non-Blocking

This illustrates the multiple command non-blocking method.

18 Troubleshooting and Technical Support

This chapter provides the following information:

- *Troubleshooting, see Chapter 18.1*
- *IO-Link Master LEDs, see Chapter 18.2*
- *Contacting Technical Support, see Chapter 18.3*
- *Using Log Files, see Chapter 18.4*

18.1 Troubleshooting

Before contacting Technical Support, you may want to try the following:

- Check to make sure LEDs are not reporting an issue using IO-Link Master LEDs.
- Verify that the network IP address, subnet mask, and gateway are correct and appropriate for the network. Make sure that the IP address programmed into the IO-Link Master matches the unique reserved IP configured address assigned by the system administrator.
 - If using DHCP, the host system needs to provide the subnet mask. The gateway is optional and is not required for a purely local network.
 - Remember that if the rotary switches on the MD 758i-11-42/L5-2222 are set to a non-default position, the rotary switches override the lower 3 digits (8 bits) of the static IP address configured in the **Network** page.
 - Verify that the Ethernet hub and any other network devices between the system and the IO-Link Master are powered up and operating.
- Verify that you are using the correct types of cables on the correct connectors and that all cables are connected securely.
- Disconnect and re-connect the IO-Link device, or optionally, use the **Configuration | IO-Link** page to **Reset** the port, and then set the **Port Mode** back to **IO-Link**.
- Reboot or power cycle the IO-Link Master. Use the **Advanced | Software** page to reboot the IO-Link Master.
- Verify that the **Port Mode** matches the device, for example: IO-Link, Digital In, Digital Out, or Reset (port is disabled).
- If you are receiving an error that indicates a hardware fault, check the **Configuration | IO-Link** page for the port experiencing the fault.
 - Check the settings for the **Automatic Upload Enable** and **Automatic Download Enable** options. If the Vendor ID or Device ID of the attached device does not match, a hardware fault is generated.
 - Make sure if the port contains data storage that the Vendor ID and Device ID match the device attached to the port. If it does not, **CLEAR** the data storage or move the device to another port.
 - Check the Device Validation and Data Validation settings. If the attached device does not meet these settings, a hardware fault is issued.
- Open the IO-Link Master web interface and review the following pages to see if you can locate a problem:
 - **IO-Link Diagnostics**
 - **Digital I/O Diagnostics**
 - **Ethernet/IP, Modbus/TCP**
- If you have a spare IO-Link Master, try replacing the IO-Link Master.

18.2 IO-Link Master LEDs

The following tables provide LED descriptions:

18.2.1 MD 758i-11-42/L5-2222

The MD 758i-11-42/L5-2222 (4-port IP67 model) provides these LEDs.

MD 758i-11-42/L5-2222 LEDs	
PWR	A lit green PWR LED indicates that the IO-Link Master is powered.
MOD (Module Status)	The MOD LED provides the following information: <ul style="list-style-type: none"> • Off = No errors or there is no PLC connection • Flashing red <ul style="list-style-type: none"> • One or more errors detected when NET is off • Fatal error when NET is also flashing • Steady red = Maintenance required or demanded
NET (Network Status)	The NET LED provides the following information: <ul style="list-style-type: none"> • Off = No PLC connection • Steady green = PLC connection established • Flashing red = Fatal error when MOD is also flashing
1-4 	This LED provides the following information about the IO-Link port. <ul style="list-style-type: none"> • Off: SIO mode - signal is low or disconnected. • Yellow: SIO mode - signal is high. • Flashing red: Hardware fault - make sure that configured IO-Link settings on the port do not conflict with the device that is attached: <ul style="list-style-type: none"> • Automatic Upload and/or Download is enabled and it is not the same device. • Device Validation Mode is enabled and it is not the correct device. • Data Validation Mode is enabled but there is an error. • Solid red - PDI of the attached IO-Link device is invalid. • Solid Green: An IO-Link device is connected and communicating. • Blinking Green: Searching for IO-Link devices.
Ports 1-4 DI	The DI LED indicates digital input on DI (Pin 2). <ul style="list-style-type: none"> • Off: DI signal is low or disconnected • Yellow: DI signal is high
EIP 1 EIP 2	The EIP LEDs provide the following information: <ul style="list-style-type: none"> • Green /Blinking = Activity • Green/lit LED = Link established

18.2.2 MD 258i-12-8K/L4-2R2K

The MD 258i-12-8K/L4-2R2K (8-port IP20 DIN rail model) provides these LEDs.

MD 258i-12-8K/L4-2R2K LEDs	
PWR	A lit green PWR LED indicates that the IO-Link Master is powered.
MS (Module Status)	<p>The MS LED provides the following information:</p> <ul style="list-style-type: none"> • Off = No errors or there is no PLC connection • Flashing green and red = Self-test • Flashing green = Standby – not configured • Steady green = Operational • Flashing red <ul style="list-style-type: none"> • One or more errors detected when NS is off • Fatal error when NS is also flashing red • Steady red = Maintenance required or demanded
NS (Network Status)	<p>The NS LED provides the following information:</p> <ul style="list-style-type: none"> • Off = No PLC connection • Flashing green and red = Self-test • Flashing green = An IP address is configured, but no connections are established • Steady green = PLC connection established • Flashing red = Fatal error when MS is also flashing • Steady red = Duplicate IP address on network
Port 1-8	<p>This LED provides the following information about the IO-Link port.</p> <ul style="list-style-type: none"> • Off: SIO mode - signal is low or disabled • Yellow: SIO mode - signal is high • Flashing red: Hardware fault - make sure that configured IO-Link settings on the port do not conflict with the device that is attached: <ul style="list-style-type: none"> • Automatic Upload and/or Download is enabled and it is not the same device. • Device Validation Mode is enabled and it is not the correct device. • Data Validation Mode is enabled but there is an error. • Solid red - PDI of the attached IO-Link device is invalid. • Solid Green: An IO-Link device is connected and communicating • Blinking Green: Searching for IO-Link devices
D1-4	<p>The D1 - D4 LEDs indicates digital input.</p> <p>Off: DI signal is low or disconnected</p> <p>On: DI signal is high</p>
Dual Ethernet Ports	<p>The Ethernet LEDs provide the following information:</p> <p>Green/Solid = Link</p> <p>Yellow/Solid = Activity</p>

18.3 Contacting Technical Support

You may want to access the **Help/SUPPORT** page when you call Technical Support, as they may request the information displayed on the **SUPPORT** page.

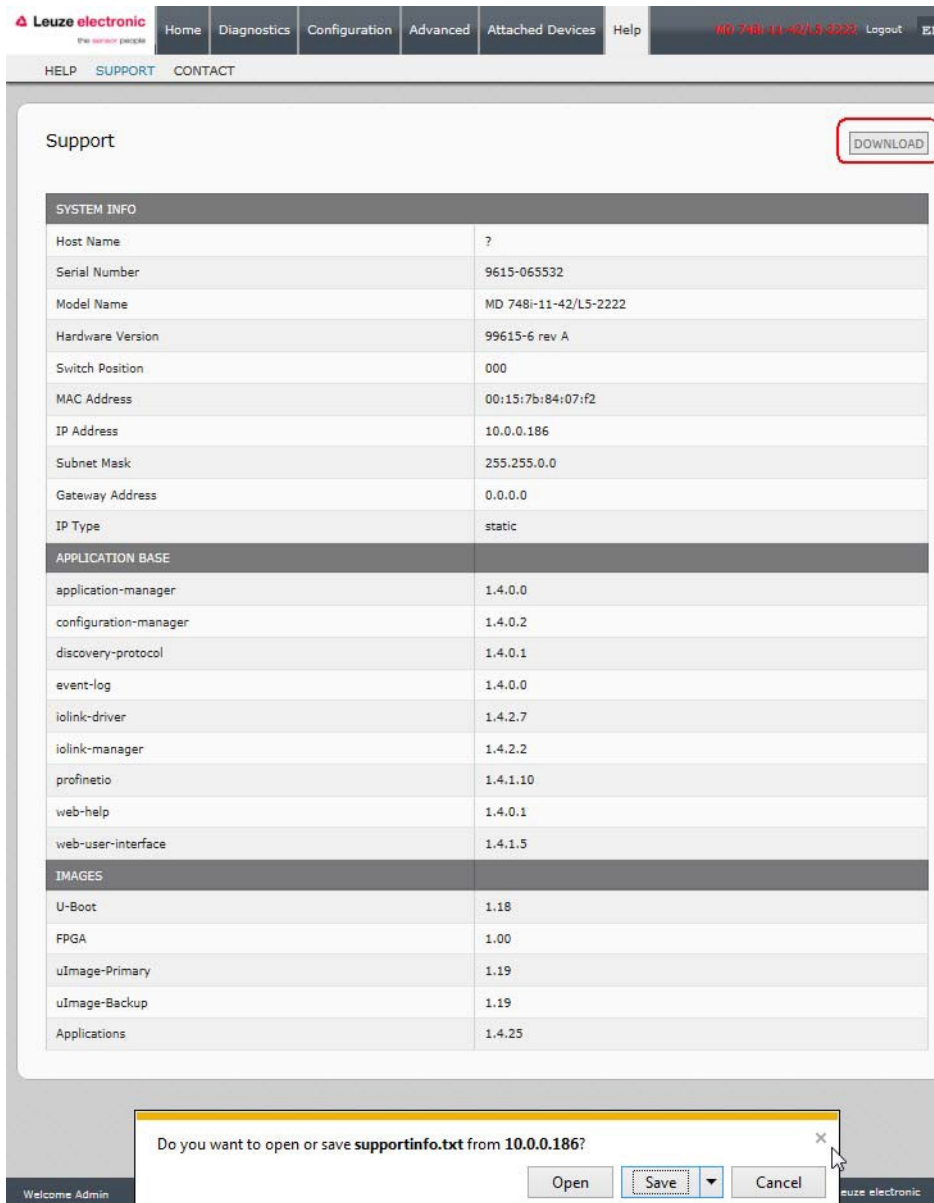

Figure 63: Saving device support information

Use the *Contact* page for information in the event you need technical assistance.

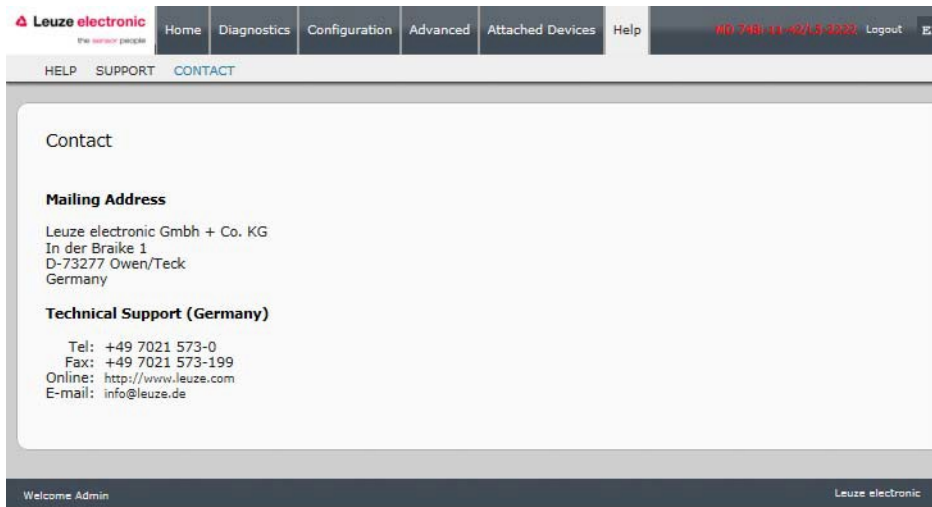

Figure 64: Support information

Service and support

24-hour on-call service at:

+49 (0) 7021 573 – 0

Service hotline:

+49 (0) 7021 573 – 123

Monday to Friday 8.00 a.m. to 5.00 p.m. (UTC+1)

E-mail:

service.identify@leuze.de

Repair service and returns:

Procedure and Internet form can be found at www.leuze.com/repair

Return address for repairs:

Service center

Leuze electronic GmbH + Co. KG

In der Braike 1

D-73277 Owen / Germany

18.4 Using Log Files

The IO-Link Master provides five different log files that you can view, export, or clear:

- **Syslog** (system log) displays line-by-line activity records.
- **dmesg** displays Linux kernel messages.
- **top** displays which programs are using most of the memory and CPU.
- **ps** displays the running programs
- All log files start up automatically during the startup cycle. Each log file has a size limit of 100KB.

Note: Typically, log files are intended to be used by Technical Support in the event there is a problem.

You can use the following procedures to:

- *View a Log File*
- *Clear a Log File*
- *Export a Log File*

18.4.1 View a Log File

Use this procedure to view a log file.

1. Open the IO-Link Master web interface.
2. Click **Advanced** and then **LOG FILES**.
3. Select the log file type from the drop-list.
4. Optionally, click the **REFRESH** button to get the latest information.
5. Optionally, export the log file.

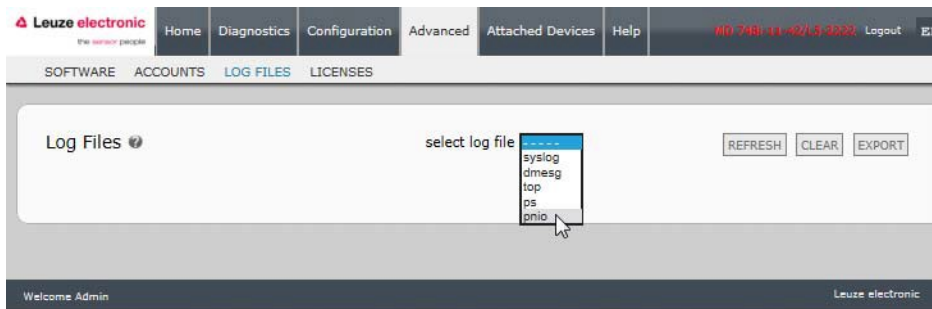

Figure 65: Select log file type

18.4.2 Export a Log File

Use the following procedure to export a log file.

1. Open the IO-Link Master web interface.
2. Click **Advanced** and then **LOG FILES**.
3. Select the log file type from the drop-list.
4. Click the **EXPORT** button.
5. Click the **Save** button drop-list and click **Save** to save it to your user folder or **Save as** to browse to or create a new folder in which to place the log file.

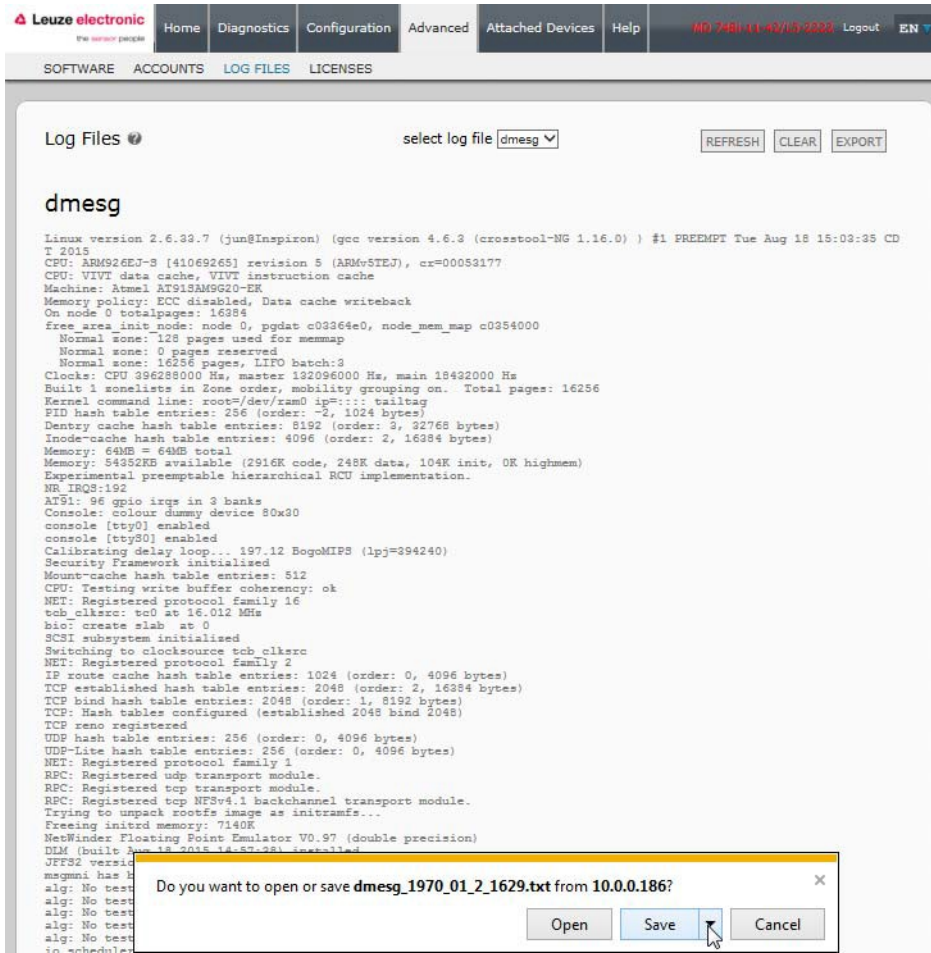

Figure 66: Save device log file

6. Depending on your operating system, you may need to close the pop-up window.

18.4.3 Clear a Log File

Use this procedure to clear a log file.

1. Open the IO-Link Master web interface.
2. Click **Advanced** and then **LOG FILES**.
3. Optionally, export the log file.
4. Select the log file type from the drop-list.
5. Click the **CLEAR** button.

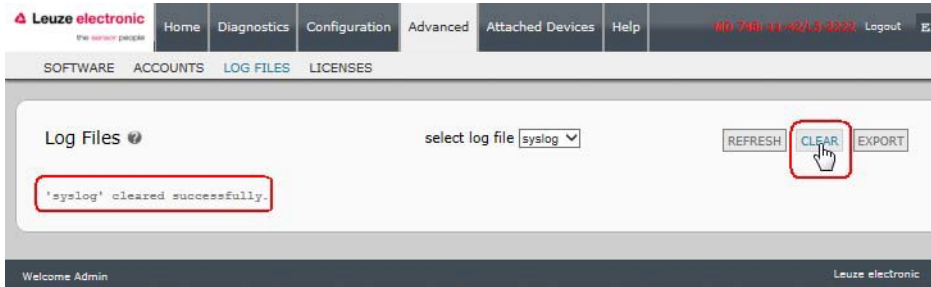

Figure 67: Clear log file

The log file automatically starts logging the latest information.

19 TYPE / SPECIFICATION

19.1 MD 758i-11-42/L5-2222

Part Nr.	50131484	MD 758i-11-42/L5-2222
HARDWARE		
Enclosure	Molded ABS (potted)	
Installation and Grounding Method	Machine or panel mount - two-hole M4 or #8 screws	
Connectors	4 - IO-Link 2 – Ethernet 2 – Power	
LED Indicators	Power, Module Status, Network Status, IO-Link, DI and Ethernet Port Status	
Dimensions	6.07" x 2.04" x 1.68" 154 x 51.8 x 42.7 mm	
ETHERNET INTERFACE SPECIFICATIONS		
Network Interfaces	10/100BASE-TX	
Network Protocols	Ethernet/IP, Modbus/TCP	
Connector Type	Female, M12 D-coded, 4-pin	
Number of Ports	2	
Standards	IEEE802.3: 10BASE-T IEEE 802.3u: 100BASE-TX	
Auto-MD/MDI-X	Yes	
Auto-Negotiation	Yes	
Link Distance	100 m	
Cable Types	Unshielded twisted pair	
IPv4 Addressing	Yes	
IO - LINK INTERFACE SPECIFICATIONS		
Connector Type	Female, M12 D-coded, 4-pin	
Number of Ports	4	
Transfer Rates	4.8K (COM1) 38.4K (COM2) 230.4K (COM3)	
Baud Rate Recognition	Automatic	
Cable Length (Max.)	20m	
DIGITAL INPUTS		
Connector Type	Female, M12 A-coded, 5-pin	
Number of Ports	4	
Input Characteristics	Type 2	
Cable Length (Max.)	30 m	
DIGITAL OUTPUTS		
Connector Type	Female, M12 A-coded, 5-pin	
Number of Ports	4	
Actuator (Sensor) Current Load (Max.)	500mA	
Lamp Load (Max.)	4W	
Over Load and Short Circuit	Yes	

Protection	
Switching Output	PNP, NPN
ELECTRICAL SPECIFICATIONS	
Device	DC Input Voltage Range 18-30VDC Current Consumption (Max.) 2A @ 24VDC Current Consumption (w/out devices) 100mA Power Consumption 2.4W
Sensor Supply Connectors 1 to 4 (Max.)	500mA/connector
Power Connectors	Input (1) Male M12 A-coded 5-pin Output (1) Female M12 A-coded 5-pin
ENVIRONMENTAL SPECIFICATIONS	
Air Temperature	System On 0°C to +55°C* System Off -40°C to +70°C
Operating Humidity (non-condensing)	10% to 95%
Storage Humidity (non-condensing)	10% to 95%
Shock/Vibrations	EN60068-2-6 EN60068-2-27
Enclosure Rating	IP67 (IEC 60529)

19.2 MD 258i-12-8K/L4-2R2K

Part Nr.	50131485	MD 258i-12-8K/L4-2R2K
HARDWARE		
Enclosure	Polyamide	
Installation and Grounding Method	DIN rail	
Connectors	DI/DO, Ethernet, IO-Link, Power	
LED Indicators	Power, Module Status, Network Status, IO-Link, DI and Ethernet Port Status	
Dimensions	4.12" x 4.47" x 1.78" 105 x 114 x 45 mm	
ETHERNET INTERFACE SPECIFICATIONS		
Network Interfaces	10/100BASE-TX	
Network Protocols	Ethernet/IP, Modbus/TCP	
Connector Type	RJ45	
Number of Ports	2	
Standards	IEEE802.3: 10BASE-T IEEE 802.3u: 100BASE-TX	
Auto-MD/MDI-X	Yes	
Auto-Negotiation	Yes	
Link Distance	100 m	
Cable Types	Unshielded twisted pair	
IPv4 Addressing	Yes	
IO - LINK INTERFACE SPECIFICATIONS		
Connector Type	Screw Terminal	
Number of Ports	8	

Transfer Rates	4.8K (COM1) 38.4K (COM2) 230.4K (COM3)
Baud Rate Recognition	Automatic
Cable Length (Max.)	20m
DIGITAL INPUTS	
Connector Type	Screw Terminal
Number of Ports	2
Input Characteristics	Type 2
Cable Length (Max.)	30 m
DIGITAL OUTPUTS	
Connector Type	Screw Terminal
Number of Ports	4
Actuator (Sensor) Current Load (Max.)	500mA
Lamp Load (Max.)	4W
Over Load and Short Circuit Protection	Yes
Switching Output	PNP, NPN
ELECTRICAL SPECIFICATIONS	
Device	DC Input Voltage Range 18-30VDC Current Consumption (Max.) 2A @ 24VDC Current Consumption (w/out devices) 100mA Power Consumption 2.4W
Sensor Supply Connectors 1 to 4 (Max.)	500mA/connector
Power Connectors	Input (1) Screw Terminal Output (1) Screw Terminal
ENVIRONMENTAL SPECIFICATIONS	
Air Temperature	System On 0°C to +70°C* System Off -40°C to +70°C
Operating Humidity (non-condensing)	10% to 95%
Storage Humidity (non-condensing)	10% to 95%
Shock/Vibrations	EN60068-2-6 EN60068-2-27
Enclosure Rating	IP67 (IEC 60529)